

# MEPG500 Series

500 W AC-DC Power Supply

Medical



The EOS Power MEPG500 Series of Medical AC-DC Power Supplies provides up to 500 W of regulated output power over a wide input range of 90–264 VAC. The power supplies are available in six single output voltages ranging from 12 V to 58 V.

The MEPG500 Series can be used in applications that require low power loss and simple thermal management.

RoHS compliant and CE marked, the power supplies are safety agency certified and meet the latest regulatory requirements.



## KEY FEATURES & BENEFITS

- New Efficient GaN power technology design
- High efficiency up to 94%
- Form factor 5 x 3 x 1.6 in (127 x 76.2 x 40.64 mm)
- Output power 500 W (Forced air cooling), 300 W (Convection cooling)
- 550 W Peak power (Up to 10 sec)
- High power density 20.83 W/inch<sup>3</sup>
- Operating temperature - 40°C to +70°C
- Thermal shut-down feature / Dual fusing
- Available with metal enclosures / accessories
- IEC / EN / ANSI AAMI 60601-1
- I<sup>2</sup>C interface communication provision added in future
- Over temperature, OV, OC and SC protection
- Stand by 5 VDC / PGPF Signal / Remote ON-OFF features (optional)
- Fan 12 VDC, 0.5 A output & Remote sense signal

## APPLICATIONS

- Therapy Devices / Hospital Beds / Imaging Equipment
- Monitoring Devices / Surgical Devices / Ultrasound
- Diagnostic Equipment / Dialysis Equipment / Drug Pump



## 1. MODEL SELECTION

MODEL NUMBER <sup>1</sup>	CONNECTION	OUTPUT VOLTAGE [V]	MIN LOAD [A]	MAX LOAD [A]		RIPPLE <sup>3</sup> [%]
				CONVECTION	400 LFM	
MEPG500-1012 <sup>2</sup>	Screw Terminal	12	0.0	20.0	33.33	2
MEPG500-1212 <sup>2</sup>	Ring Lug Terminal	12	0.0	20.0	33.33	2
MEPG500-1312 <sup>2</sup>	Molex Connector	12	0.0	20.0	24.00	2
MEPG500-1015 <sup>2</sup>	Screw Terminal	15	0.0	16.0	26.67	2
MEPG500-1215 <sup>2</sup>	Ring Lug Terminal	15	0.0	16.0	26.67	2
MEPG500-1315 <sup>2</sup>	Molex Connector	15	0.0	16.0	24.00	2
MEPG500-1024	Screw Terminal	24	0.0	12.5	20.83	1
MEPG500-1224	Ring Lug Terminal	24	0.0	12.5	20.83	1
MEPG500-1324	Molex Connector	24	0.0	12.5	20.83	1
MEPG500-1030	Screw Terminal	30	0.0	10.0	16.67	1
MEPG500-1230	Ring Lug Terminal	30	0.0	10.0	16.67	1
MEPG500-1330	Molex Connector	30	0.0	10.0	16.67	1
MEPG500-1048	Screw Terminal	48	0.0	6.25	10.41	1
MEPG500-1248	Ring Lug Terminal	48	0.0	6.25	10.41	1
MEPG500-1348	Molex Connector	48	0.0	6.25	10.41	1
MEPG500-1058	Screw Terminal	58	0.0	5.17	8.62	1
MEPG500-1258	Ring Lug Terminal	58	0.0	5.17	8.62	1
MEPG500-1358	Molex Connector	58	0.0	5.17	8.62	1

<sup>1</sup> When used in Cover Kit, de-rate output power to 70% under all operating conditions.

<sup>2</sup> See Derating Curves, page 10.

<sup>3</sup> Ripple is peak to peak with 20 MHz bandwidth and 10  $\mu$ F (Tantalum capacitor) in parallel with a 0.1  $\mu$ F capacitor at rated line voltage and load ranges.

## 2. MODEL SELECTION - MEPG500-G

MODEL NUMBER <sup>1</sup>	CONNECTION	OUTPUT VOLTAGE [V]	MIN LOAD [A]	MAX LOAD [A]		RIPPLE <sup>3</sup> [%]
				CONVECTION	400 LFM	
MEPG500-2412-G <sup>2</sup>	Dual Row header	12	0.0	20	33.33	2
MEPG500-2415-G <sup>2</sup>	Dual Row header	15	0.0	16	26.67	2
MEPG500-2424-G	Dual Row header	24	0.0	12.5	20.83	1
MEPG500-2430-G	Dual Row header	30	0.0	10	16.67	1
MEPG500-2448-G	Dual Row header	48	0.0	6.25	10.41	1
MEPG500-2458-G	Dual Row header	58	0.0	5.17	8.62	1

<sup>1</sup> When used in Cover Kit, de-rate output power to 70% under all operating conditions.

<sup>2</sup> See Derating Curves, page 10.

<sup>3</sup> Ripple is peak to peak with 20 MHz bandwidth and 10  $\mu$ F (Tantalum capacitor) in parallel with a 0.1  $\mu$ F capacitor at rated line voltage and load ranges.

### 3. MODEL NUMBER KEY

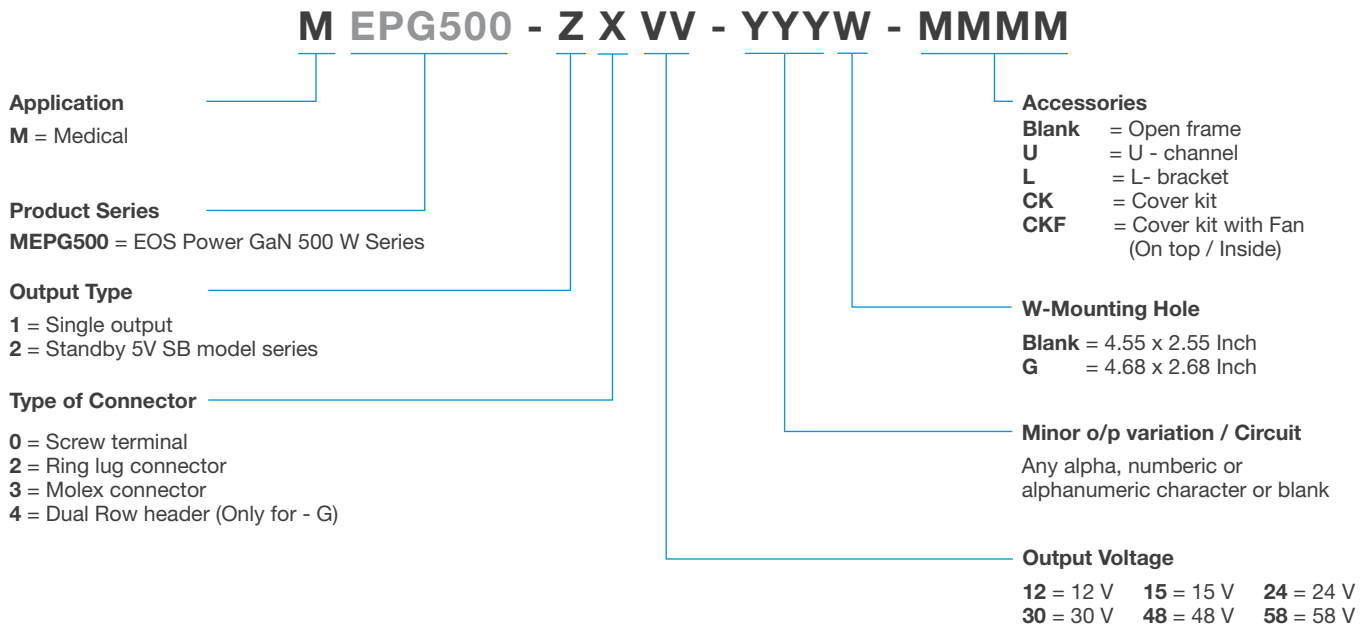

### 4. INPUT SPECIFICATIONS

PARAMETER	DESCRIPTION / CONDITIONS	MIN	TYP	MAX	UNIT
Input voltage	Derate linearly from 100% at 115 VAC to 80% at 90 VAC <sup>4</sup>	90		264	VAC
Input frequency		47		63	Hz
Input current				6.3	A
Inrush current				75	A
Leakage current			300		μA
Touch current				100	μA
Power factor		0.95			

<sup>4</sup> Refer to Derating curves



## 5. OUTPUT SPECIFICATIONS<sup>5</sup>

PARAMETER	DESCRIPTION / CONDITIONS	MIN	TYP	MAX	UNIT
Output power	Forced air cooling 400 LFM (115 to 264 VAC)			500	W
	Convection cooling (115 to 264 VAC)			300	
Efficiency	At 230 VAC	92		94	%
Hold-up time			10		ms
Line regulation		-0.5		+0.5	%
Load regulation		-0.5		+0.5	%
Output voltage adjustability		-3		+3	%
Rise time			55		ms
Set point tolerance		-1		+1	%
Transient response	Max excursion 5%; 75%-100% step load change at 0.1 A / $\mu$ s slew rate, 50% duty cycle, 50 Hz Recovery time		5		ms
Switching frequency	PFC PWM	100	130	200	kHz
Start up delay	115/230 VAC Full Load			2	s
Drift	After 20 minutes warm-up	- 0.2		+ 0.2	%
Over / Undershoot	Turn On / Off			5	%
Temperature coefficient				0.02	%/°C

<sup>5</sup> Specifications are for nominal input voltage 230 VAC, 25°C unless otherwise stated.

## 6. PROTECTIONS

PARAMETER	DESCRIPTION / CONDITIONS	MIN	TYP	MAX	UNIT
Over current protection - V1	Hiccup mode; auto recovery	110			%
Over voltage protection	Hiccup mode; auto recovery	110		140	%
Short circuit protection	Hiccup mode; auto recovery				

## 7. ENVIRONMENTAL SPECIFICATIONS

PARAMETER	DESCRIPTION / CONDITIONS	MIN	TYP	MAX	UNIT
Operating temperature	-40 to 0°C start-up is guaranteed with spec. deviation <sup>6</sup>	-40		+70	°C
Storage temperature		-40		+85	°C
Humidity	Relative	5		95	%
Altitude	Operating, RH, non-condensing			16000	ft
	Non operating, non-condensing			40000	ft

<sup>6</sup> Output ripple can be more than 10 % of the output voltage.

### 8. SIGNALS & CONTROLS - MEPG500-2XXX Series (Multifunctional card optional)

PARAMETER	DESCRIPTION / CONDITIONS
Power Good	Is a TTL signal which goes high after main output reaches 90% of its set value. The delay is 0.1 s to 0.5 s
Power Fail	The same signal goes low at least 1ms before main output falls to 90% of set value at AC Power off
Remote on/off	Shorting Pin 3 to Pin 4 enables main output while keeping the Pins open disables main output
SB output voltage <sup>7</sup>	5 VDC / 0.3 A @ 40°C, Derate linearly to 0.25 A @ 70°C

<sup>7</sup> Tolerance including set point accuracy, line and load regulation is +/-10 %. Ripple and noise is less than 5 %.

### 9. REMOTE ON / OFF

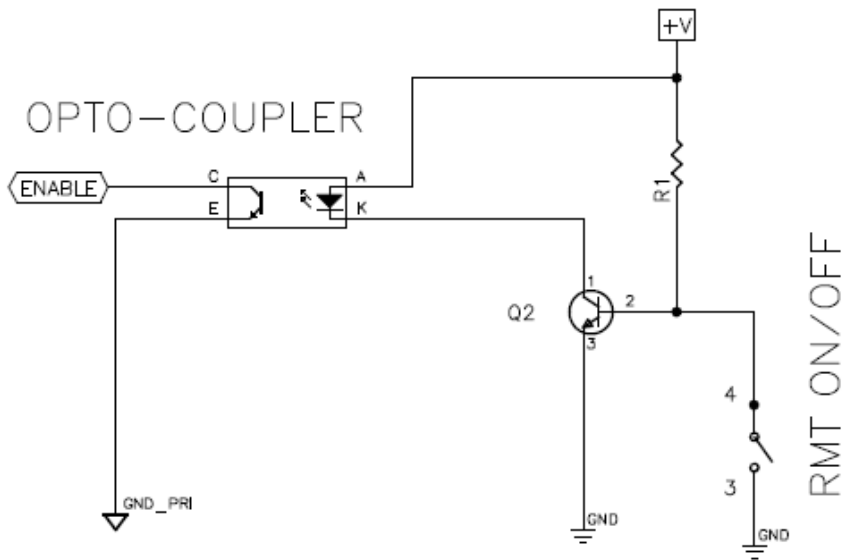

Figure 1. Remote On / Off diagram (available only for MEPG500-2XXX option)

### 10. POWER GOOD / POWER FAIL SIGNAL

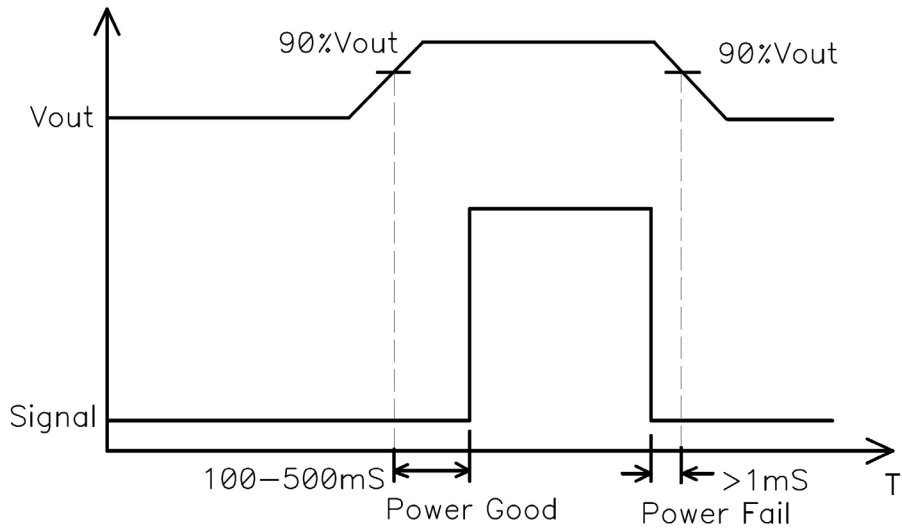

Figure 2. PG / PF signal diagram (available only for MEPG500-2XXX option)

### 11. VOLTAGE SENSE DRAWING

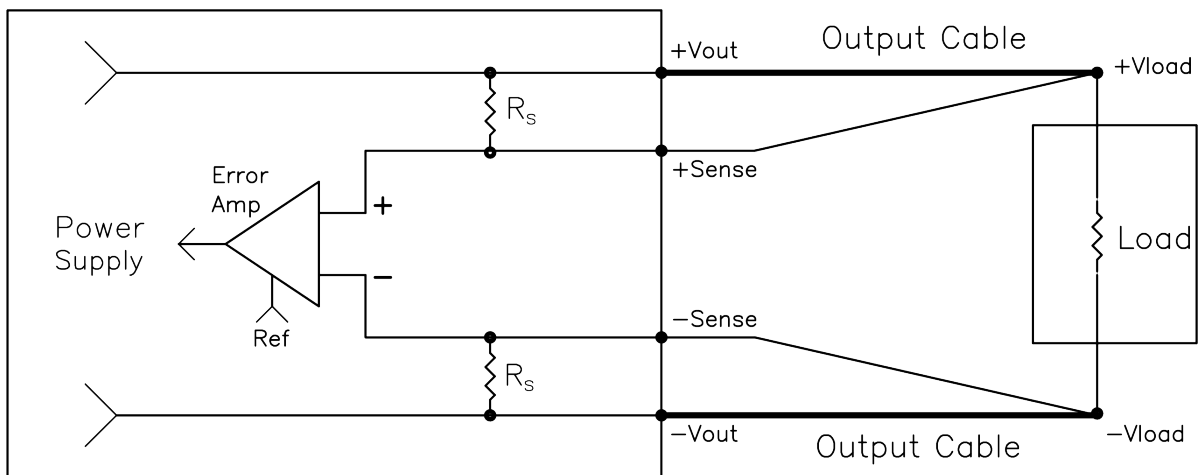

Figure 3. Voltage sense diagram

## 12. EMC SPECIFICATIONS

PARAMETER	DESCRIPTION / CONDITIONS	CLASS / LEVEL / CRITERION
Conducted emissions	EN 55011 / EN 55032, CISPR22-B, FCC PART15-B	Level B
Radiated emissions	EN 55011 / EN 55032,	Level A
	With external core (King core K5B RC 25x12x15-M or equivalent in input cable)	Level B
Harmonic current	EN 61000-3-2	Class A
Fluctuation and Flicker	EN 61000-3-3	Compliance
ESD immunity	EN 61000-4-2	Level 4, Criterion A
Radiated field immunity	EN 61000-4-3	Level 3, Criterion A
Electrical fast transient	EN 61000-4-4	Level 3, Criterion A
Surge immunity	EN 61000-4-5	Level 3, Criterion A
Conducted immunity	EN 61000-4-6	Level 3, Criterion A
Magnetic field immunity	EN 61000-4-8	Level 4, Criterion A
Voltage dips, interruptions	EN 61000-4-11	Criterion A & B
Standard IEC 60601-1-2:2014 (4 <sup>th</sup> Edition)		

## 13. SAFETY SPECIFICATIONS

PARAMETER	DESCRIPTION / CONDITIONS	MIN	TYP	MAX	UNIT
Safety approvals (Pending)	IEC 60601-1, EN 60601-1 ANSI / AAMI ES 60601-1 & CSA C22.2, No.60601-1		Medical		
Equipment protection class	Class I				
Isolation	Input to Output (2x MOPP)	4000			VAC
	Input to Ground (1x MOPP)	1500			
	Output to Ground (1x MOPP)	1500			
MTBF	Telcordia -SR332-issue 3	800			khrs

## 14. MECHANICAL SPECIFICATIONS

PARAMETER	DESCRIPTION / CONDITIONS	MIN	TYP	MAX	UNIT
Dimensions			127 x 76.2 x 40.64		mm
			5 x 3 x 1.6		in
Weight			450		g
Cooling	Forced air cooling		400 LFM		
	Convection cooling		Natural air flow		



## 15. CONNECTORS & PIN DESCRIPTION

CONNECTION	PIN	PIN	DESCRIPTION	CONNECTOR	MANUFACTURER PN
AC Input	J1	Pin 1 Pin 2 Pin 3	AC LINE NOT FITTED AC NEUTRAL		Molex: 26-60-4030 Mating: 09-50-3031; Pins: 08-50-0106
DC Output	J2	Pin 1,2,3,4 Pin 5,6,7,8	V1 +VE V1 -VE	Screw terminal  Molex connector  Ring Lug terminal	6-32 inches Screw Pan HD Vertical Mating: Designed to accept Ring Tongue Terminal AMP: 8-31886-1  Molex MPN: Header Molex p/n: 26-60-4080 or equivalent Mating part no: A: Hosuing Molex p/n: 09-50-3081 or equivalent B: Pins Molex p/n: 08-50-0106 or equivalent  The DC output terminals are designed to accept a ring-lug terminal. These terminal use 6-32 screw. Ring terminal: Tyco 35148 or KST RV3-4 or equivalent
Aux Output (Fan)	J6	Pin 1 Pin 2	FAN+ FAN-		AMP: 640456-2 Mating: 640440-2
Aux Output (Signal)	J9	Pin 1 Pin 2	+VS -VS		Header 2 POS 2.54MM p/n: P9102-40-12-1 Mating part no: CONN RCPT HSNG 2POS CST-100 II p/n: 1375820 - 2 Pins: CONN SOCKET 22-26AWG CRIMP TIN p/n: 1375819-1
Multifunction Connector	J10	Pin 1 Pin 2,3 Pin 4 Pin 5	5 VDC GND ON / OFF PGPF		Header 5 POS 2.54MM p/n: P9102-40-12-1 Mating part no: CONN RCPT HSNG 5POS CST-100 II p/n: 1375820-5 Pins: CONN SOCKET 22-26AWG CRIMP TIN p/n: 1375819-1
Earth	J4				Molex: 19705-4301 Mating: 19003-0001

## 16. CONNECTORS & PIN DESCRIPTION (MEPG500-G)

CONNECTION	PIN	PIN	DESCRIPTION	CONNECTOR	MANUFACTURER PN
AC Input	J1	Pin 1 Pin 2 Pin 3	AC LINE NOT FITTED AC NEUTRAL		Molex: 41671-3473 Mating: 09-50-8031; Pins: 08-50-0106
DC Output	J2	Pin 1,2,3,4 Pin 5,6,7,8	V1 +VE V1 -VE	Header Dual Row	Molex: 172298-1208 Mating: 172258-3108
Aux Output (Fan)	J6	Pin 1 Pin 2	FAN + FAN -		AMP: 640456-2 Mating: 640440-2
Multifunction Connector	J10	Pin A1,A2 Pin A3,B1 Pin A4 Pin A5 Pin B2,B3 Pin B4 Pin B5	5 VDC NC +VS -VS GND PG ON / OFF	Header Dual Row	FCI: 98414-G04-10ULF Mating part no: FCI 90311-010LF
Earth	J4				Molex: 19705-4301 Mating: 19003-0001



### 17. DERATING CURVES

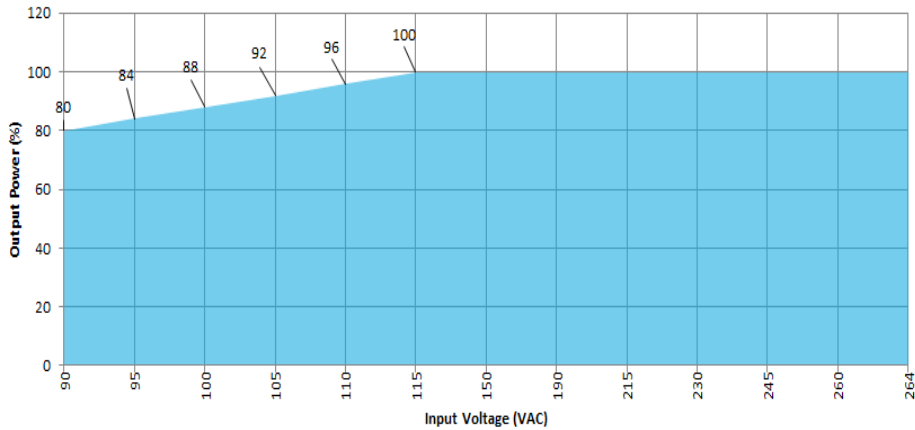

Notes: De-rate linearly from 100% at 115 VAC to 80% at 90 VAC

Figure 4. Output Power Derating w.r.t. Input

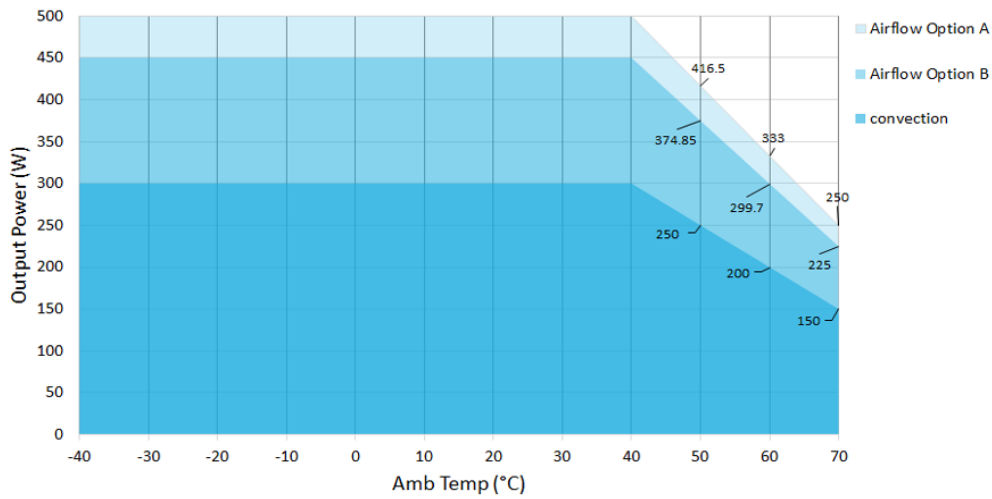

Notes: Convection load: 300 W up to 40°C; derate above 40°C @ 1.67% per °C  
 Forced air load for Airflow Option A: 500 W up to 40°C derate above 40°C @ 1.67 % per °C  
 Forced air load for Airflow Option B: 450 W up to 40°C derate above 40°C @ 1.67 % per °C

Figure 5. Power Derating of 24 V, 30 V, 48 V & 58 V models (Open frame / L channel / U bracket options)



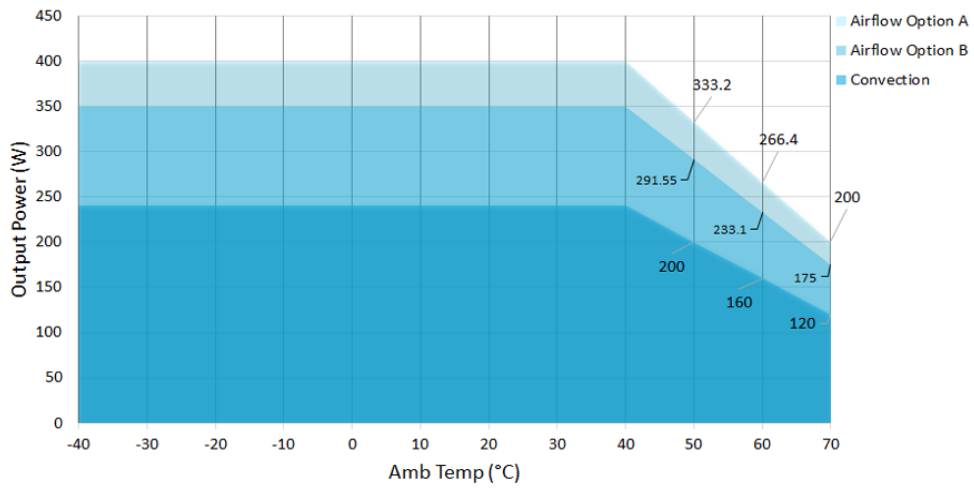

Notes: Convection load: 240 W up to 40°C; derate above 40 °C @ 1.67% per °C  
 Forced air load for Airflow Option A: 400 W up to 40 °C derate above 40 °C @ 1.67 % per °C  
 Forced air load for Airflow Option B: 350 W up to 40 °C derate above 40 °C @ 1.67 % per °C

Figure 6. Power Derating of 12 V & 15 V models (Open frame / L channel / U bracket options)

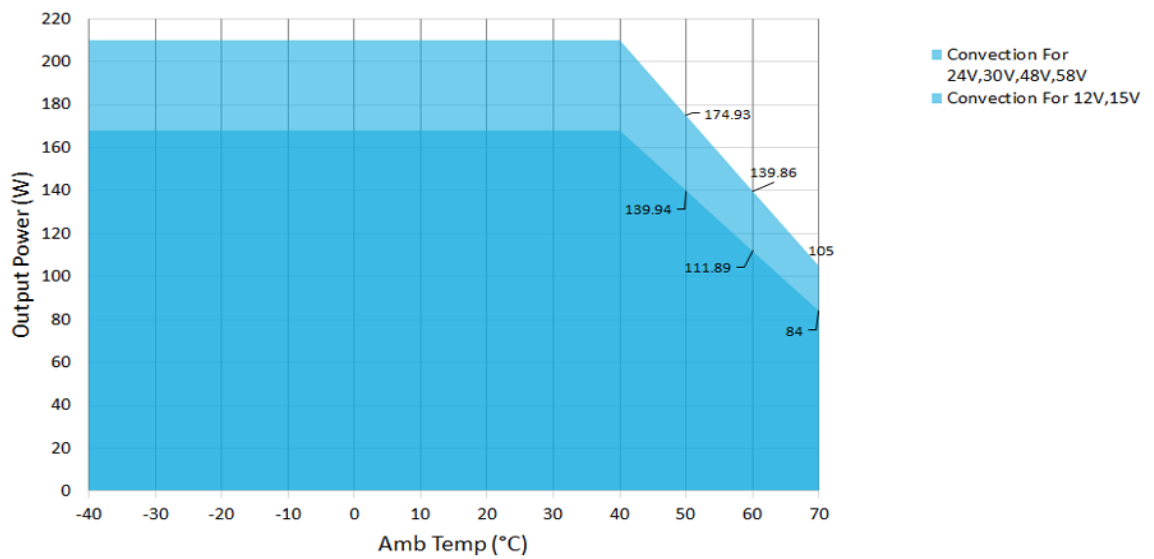

Notes: Convection load for 24 V to 58 V: 210 W up to 40°C; derate above 40 °C @ 1.67% per °C  
 Convection load for 12 V,15 V: 168 W up to 40°C; derate above 40 °C @ 1.67 % per °C

Figure 7. Power Derating of 12 V to 58 V models (Cove kit option)

18. MECHANICAL DRAWINGS

MEPG500-1XXX WITHOUT MULTI CARD

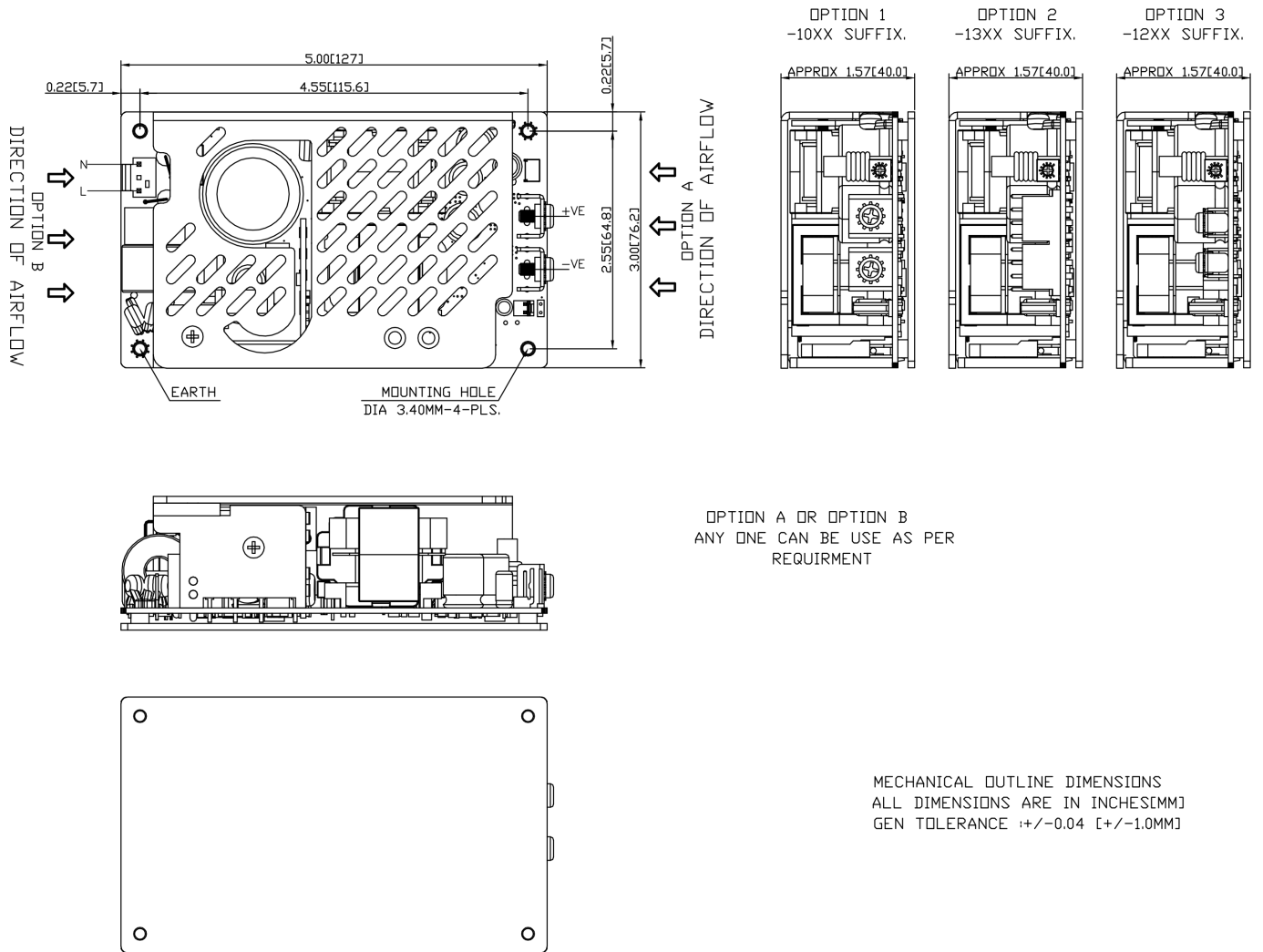
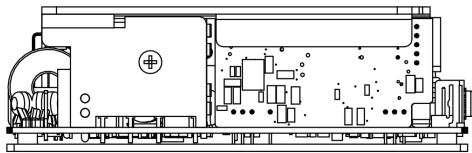
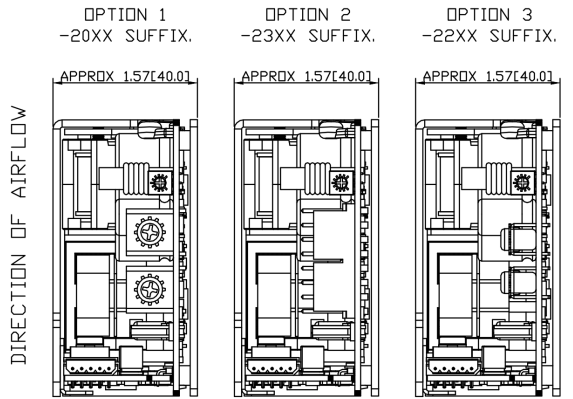
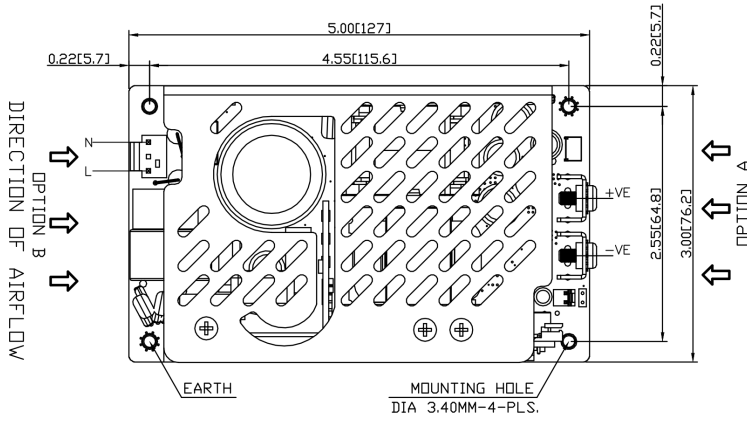

Figure 8. Mechanical Drawing – MEPG500-1XXX Without Multi card



MEPG500-2XXX WITH MULTI CARD



OPTION A OR OPTION B  
ANY ONE CAN BE USE AS PER  
REQUIRMENT



MECHANICAL OUTLINE DIMENSIONS  
ALL DIMENSIONS ARE IN INCHES[MM]  
GEN TOLERANCE  $\pm 0.04$  [ $\pm 1.0$ MM]

Figure 9. Mechanical Drawing – MEPG500-2XXX With Multi card

MEPG500-1XXX L

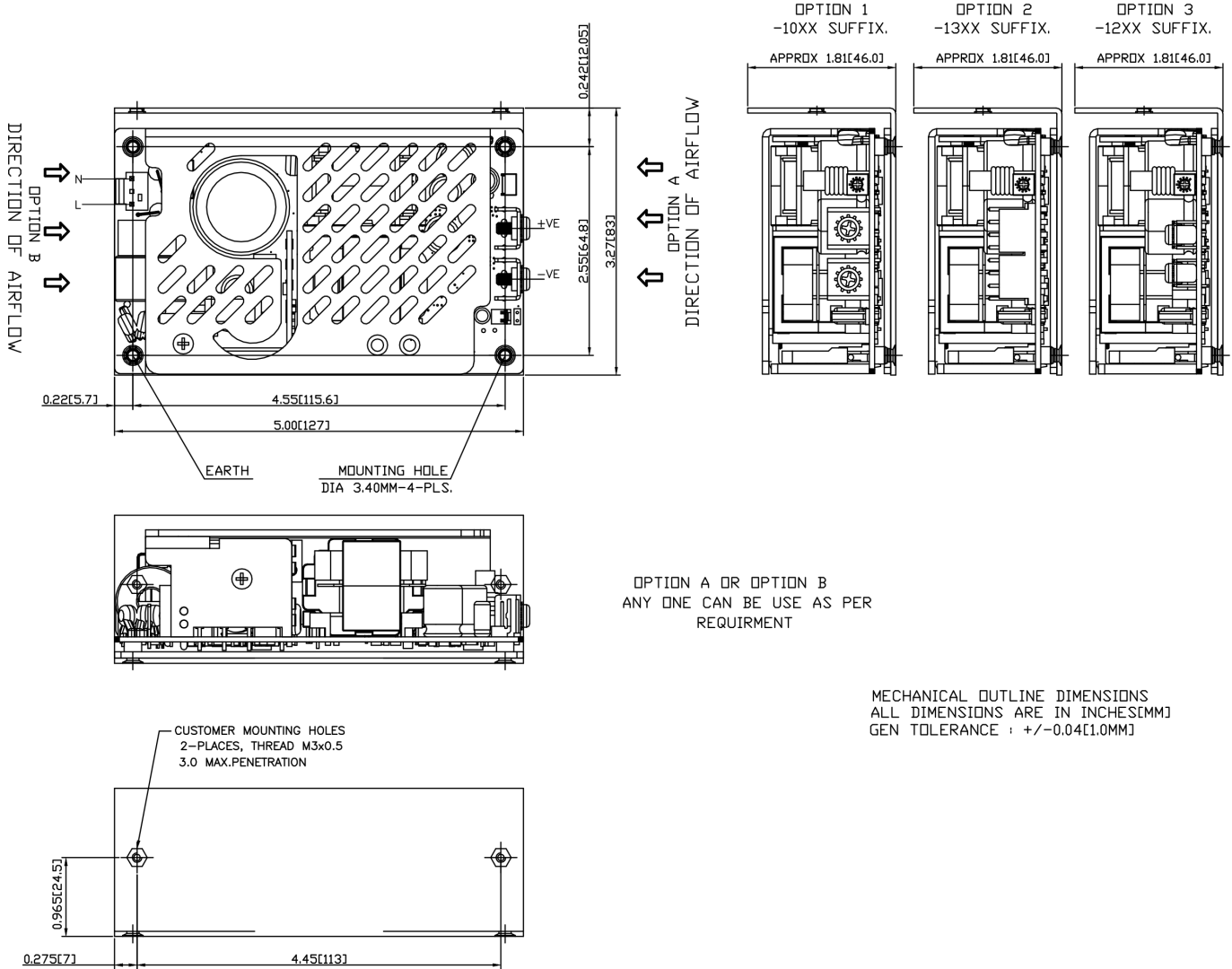
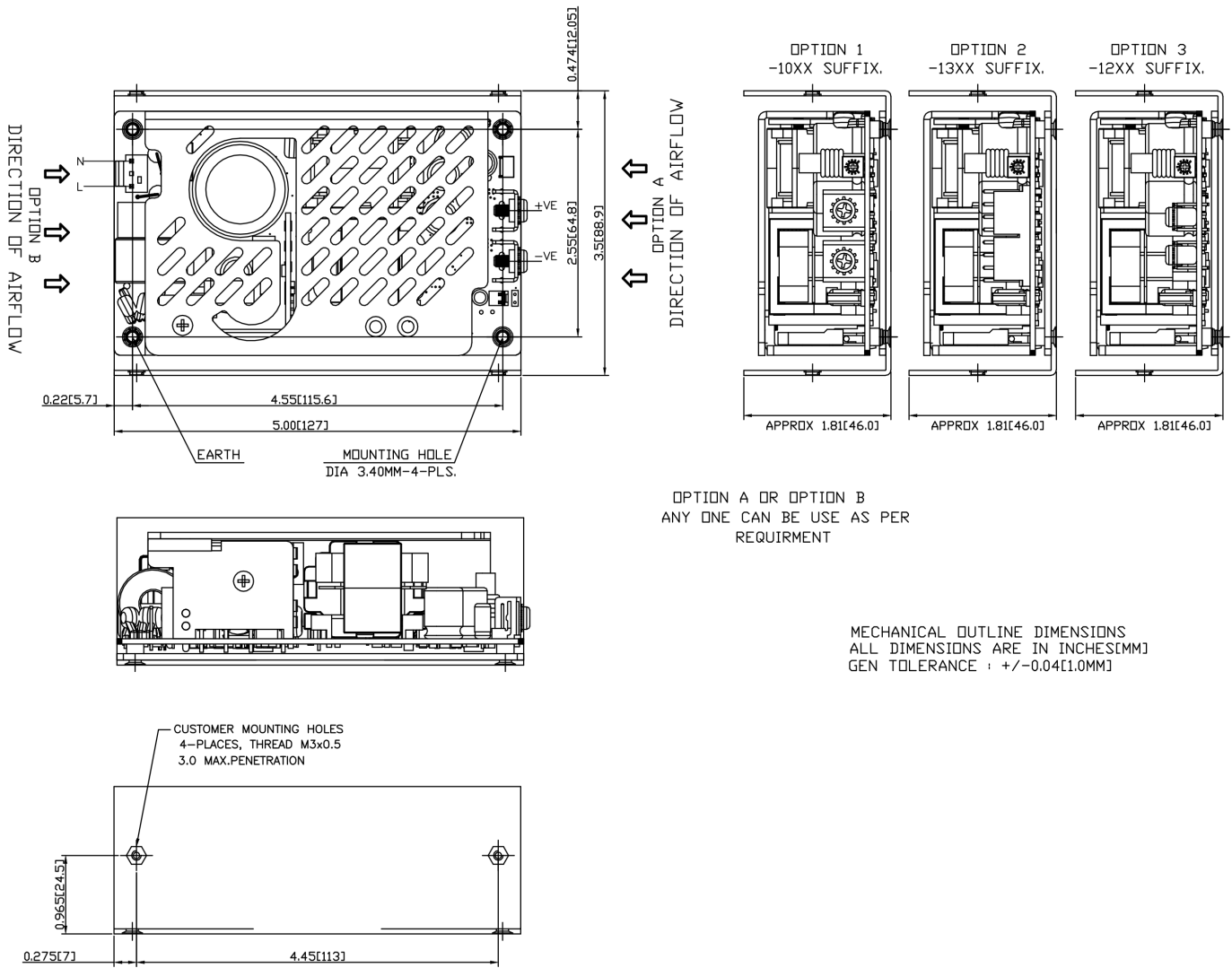

Figure 10. Mechanical Drawing – MEPG500-1XXX L

MEPG500-1XXX U



OPTION A OR OPTION B  
ANY ONE CAN BE USE AS PER  
REQUIRMENT

MECHANICAL OUTLINE DIMENSIONS  
ALL DIMENSIONS ARE IN INCHES[MM]  
GEN TOLERANCE : +/-0.04[1.0MM]

Figure 11. Mechanical Drawing – MEPG500-1XXX U

**MEPG500-1XXX-COVER KIT**

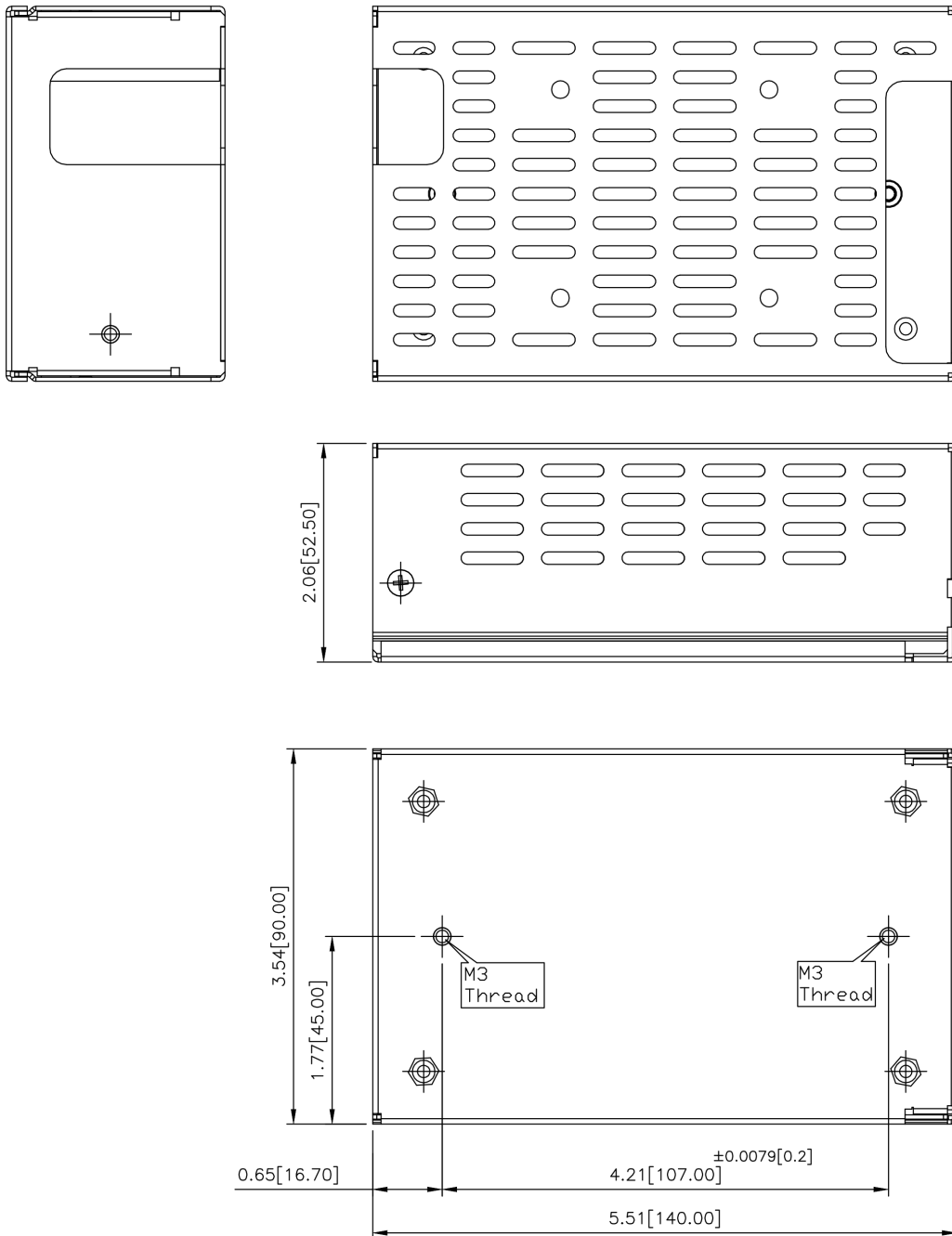

MECHANICAL OUTLINE DIMENSIONS  
 ALL DIMENSIONS ARE IN INCHES[MM]  
 GEN TOLERANCE : +/-0.04[1.0MM]

Figure 12. Mechanical Drawing – MEPG500-1XXX Cover Kit



MEPG500-1XXX-COVER KIT WITH FAN

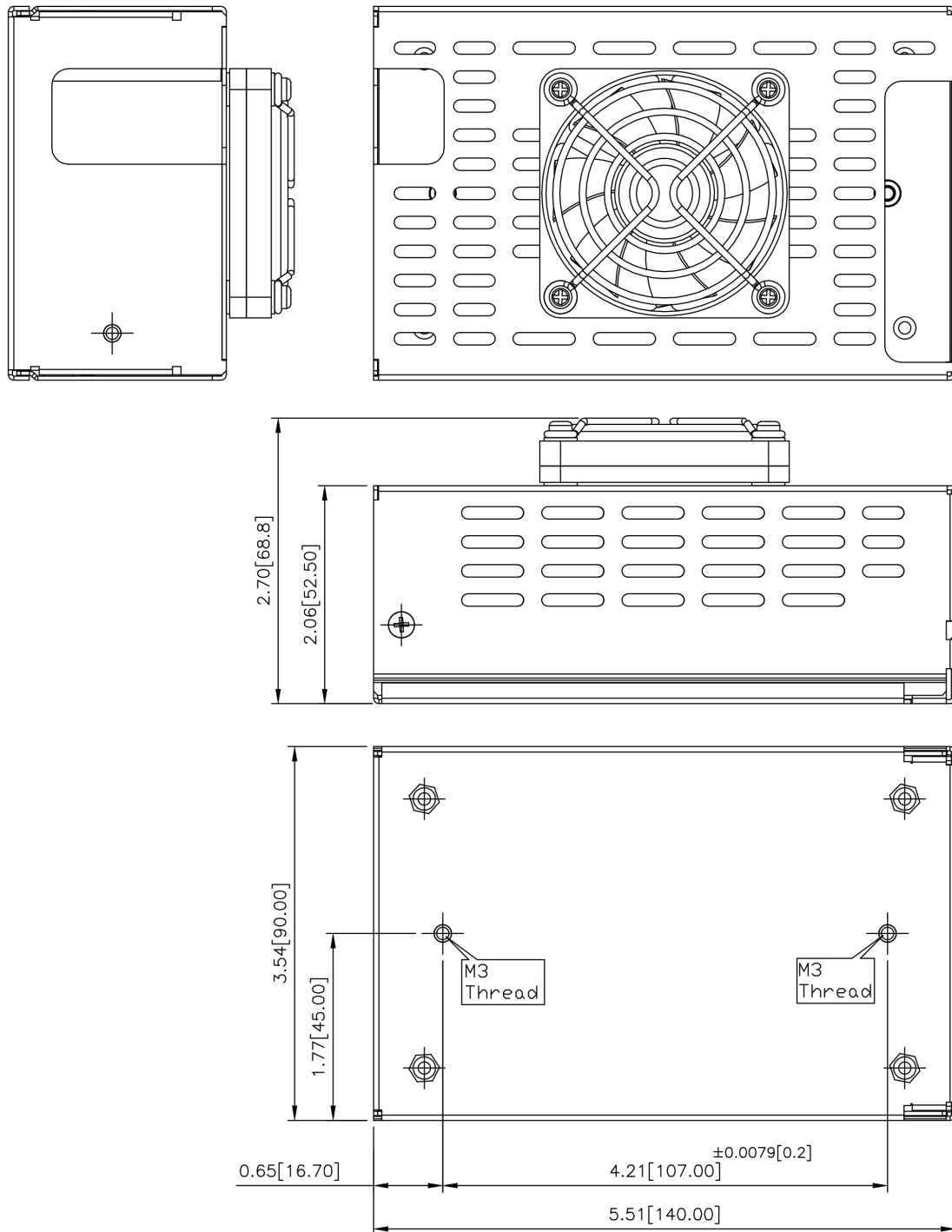

MECHANICAL OUTLINE DIMENSIONS  
 ALL DIMENSIONS ARE IN INCHES[MM]  
 GEN TOLERANCE : +/-0.04[1.0MM]

Figure 13. Mechanical Drawing – MEPG500-1XXX Cover Kit with Fan



MEPG500-2XXX L

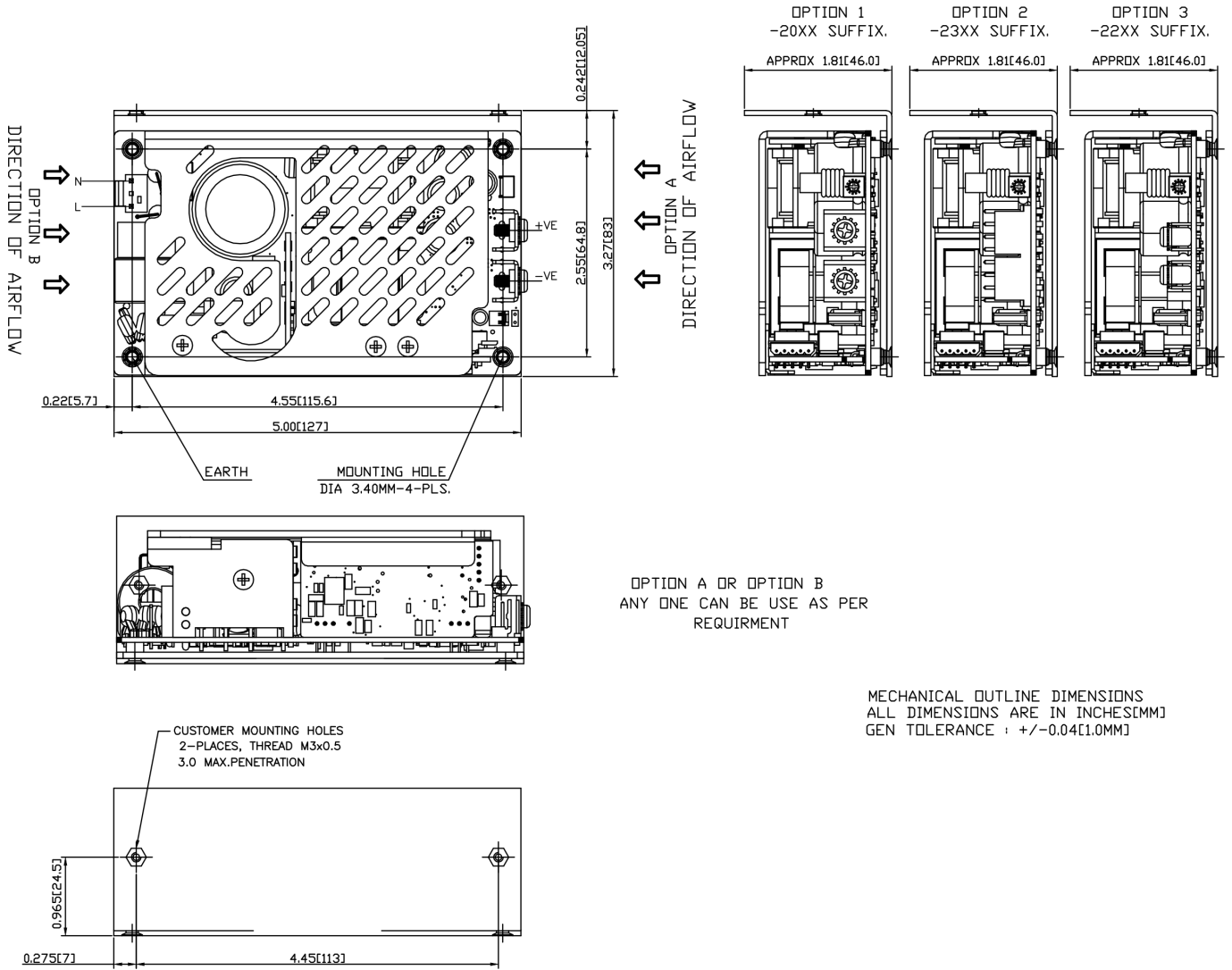

OPTION A OR OPTION B  
ANY ONE CAN BE USE AS PER  
REQUIREMENT

MECHANICAL OUTLINE DIMENSIONS  
ALL DIMENSIONS ARE IN INCHES[MM]  
GEN TOLERANCE : +/-0.04[1.0MM]

Figure 14. Mechanical Drawing – MEPG500-2XXX L

MEPG500-2XXX U

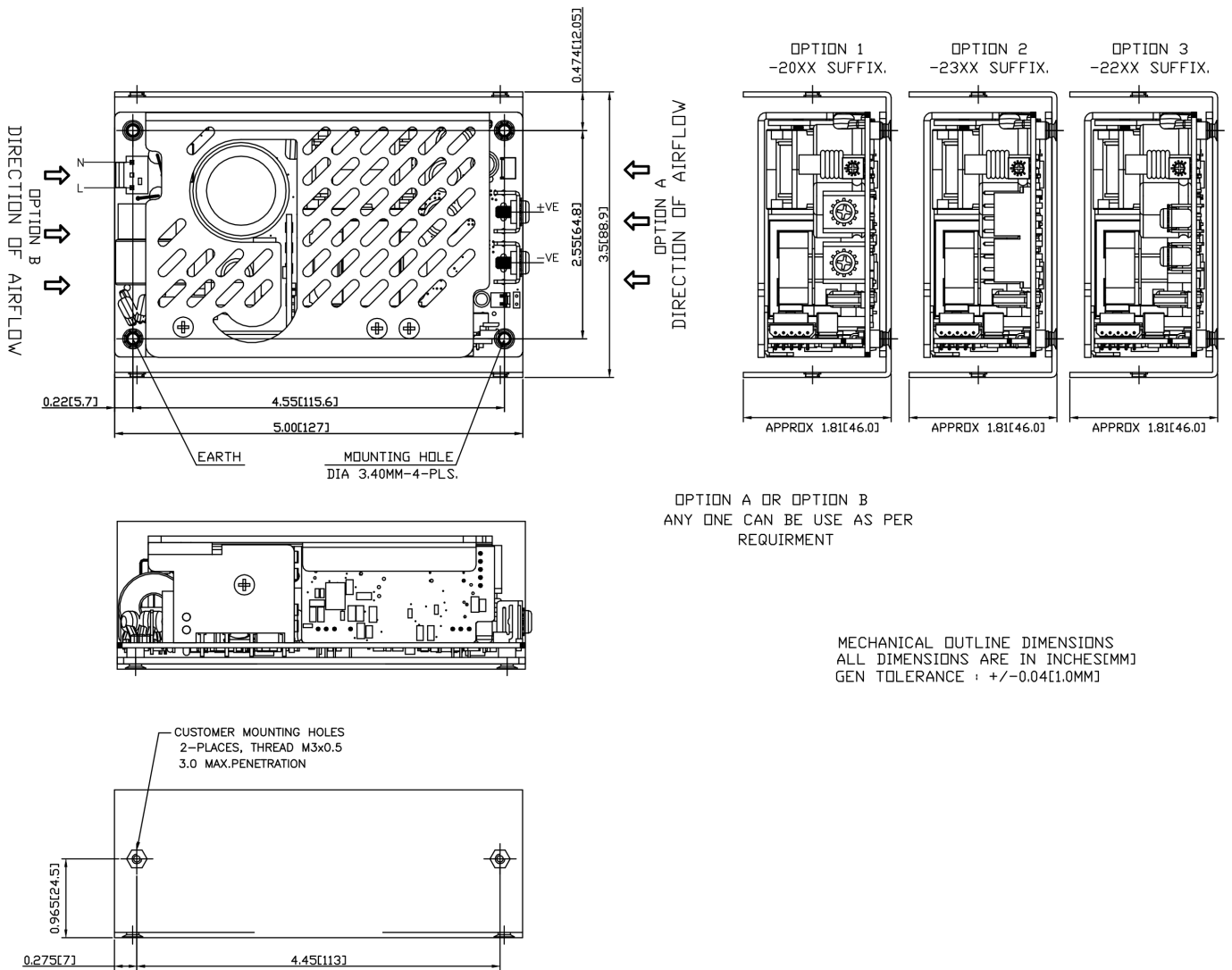

Figure 15. Mechanical Drawing – MEPG500-2XXX U

MEPG500-24XX G

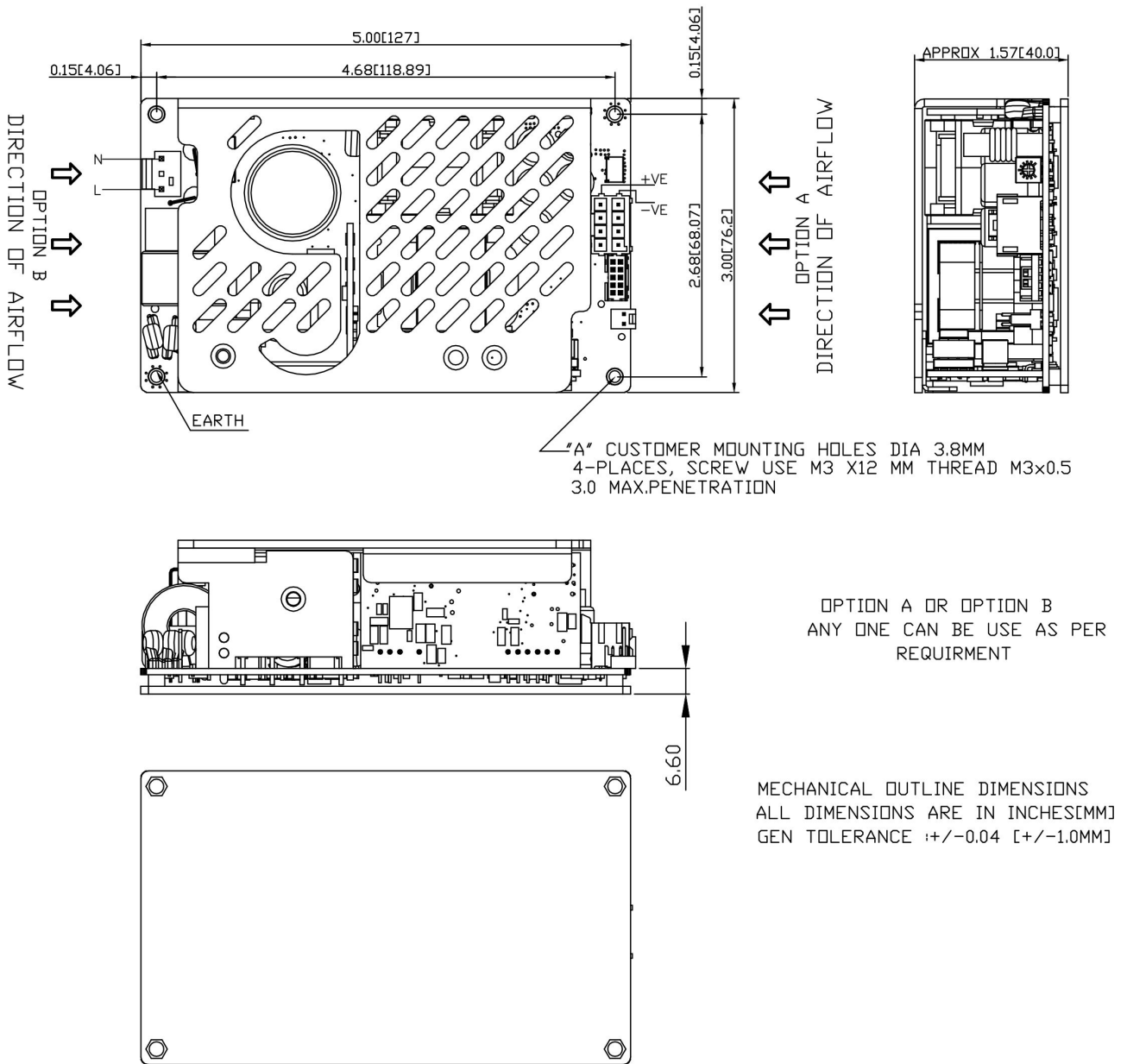

Figure 16. Mechanical Drawing – MEPG500-24XX G

**NUCLEAR AND MEDICAL APPLICATIONS** - Products are not designed or intended for use as critical components in life support systems, equipment used in hazardous environments, or nuclear control systems.

**TECHNICAL REVISIONS** - The appearance of products, including safety agency certifications pictured on labels, may change depending on the date manufactured. Specifications are subject to change without notice.



Asia-Pacific  
+86 755 298 85888

EMEA  
+353 61 49 8941

North America  
+1 866 513 2839

[belfuse.com](http://belfuse.com)