

DATE	REV	ECN	APP'D. BY
6-13-17	A0	-	DHG
5-15-20	A1	11552	JE
9-3-24	A2	12431	JE

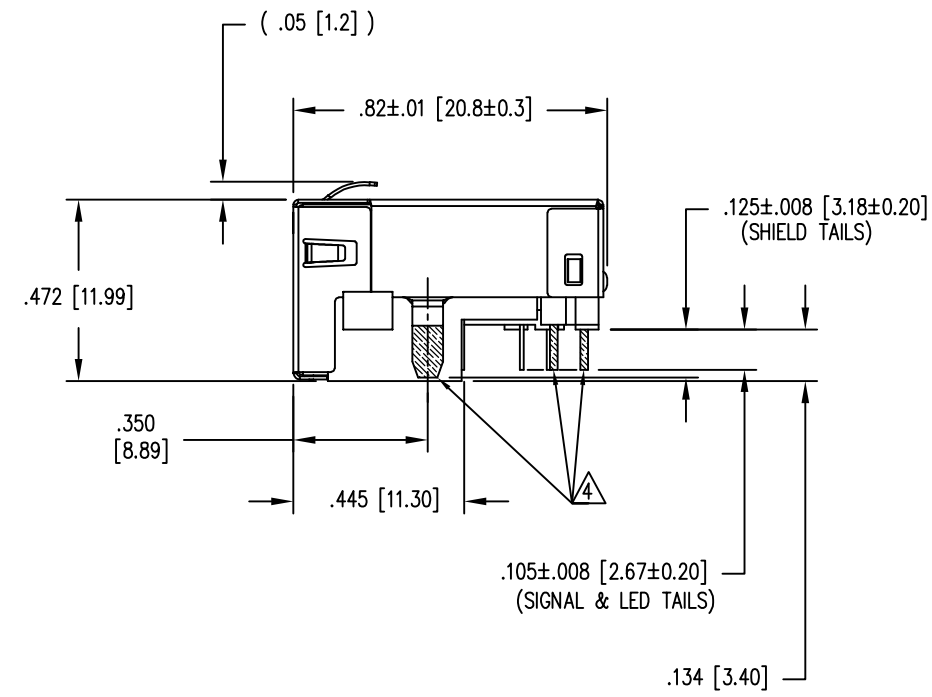

- NOTES:
- CONNECTOR MATERIALS:
HOUSING: HALOGEN FREE THERMOPLASTIC, UL94 V-0
CONTACTS: COPPER ALLOY
SHIELD: STAINLESS STEEL OR NICKEL PLATED STAINLESS STEEL
CONTACT PLATING: SELECTIVE GOLD IN CONTACT AREA (SEE CHART FOR PART NUMBER)
MATTE TIN PLATED SOLDER TAILS
 - FOR PRODUCT SPECIFICATIONS SEE PRO22-01.
 - DIMENSIONS AND TOLERANCES COMPLY WITH TIA-1096 STANDARD.
 - SHIELD AND LED LEADS ARE TIN DIPPED OR TIN PLATED TO .010 MIN ABOVE TOP SURFACE OF PRINTED CIRCUIT BOARD SEATING PLANE. NO EXPOSED BASE METAL IN THIS AREA.
 - IR REFLOW COMPATIBLE MAX. 260°C FOR MAX. 10 SECONDS.
 - DESIGNED FOR CATEGORY 5/5e APPLICATIONS.

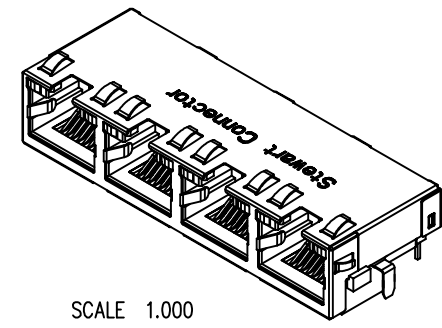
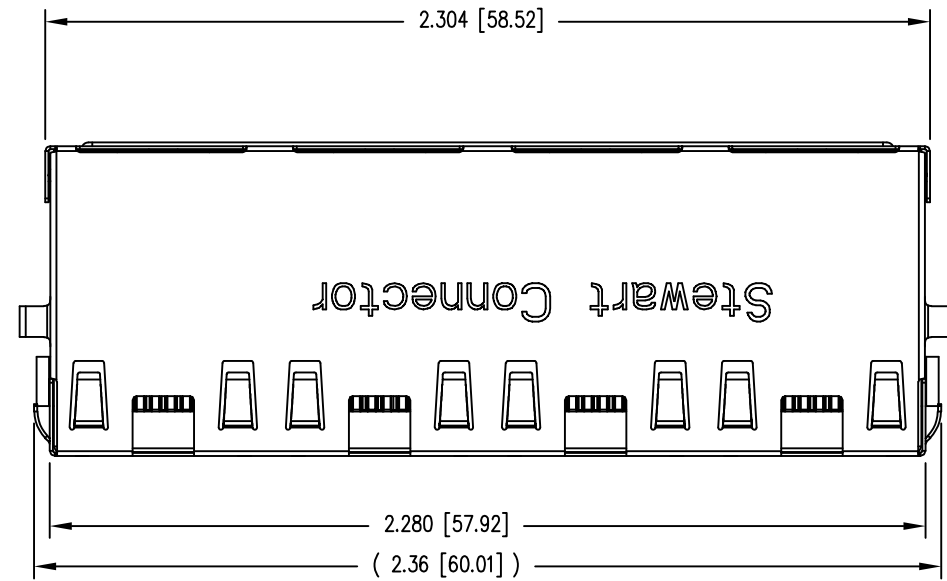
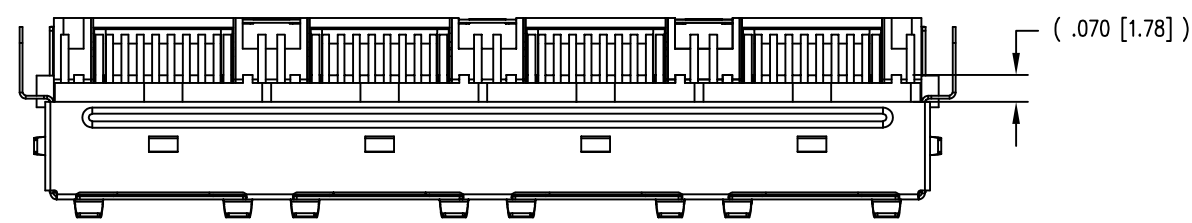
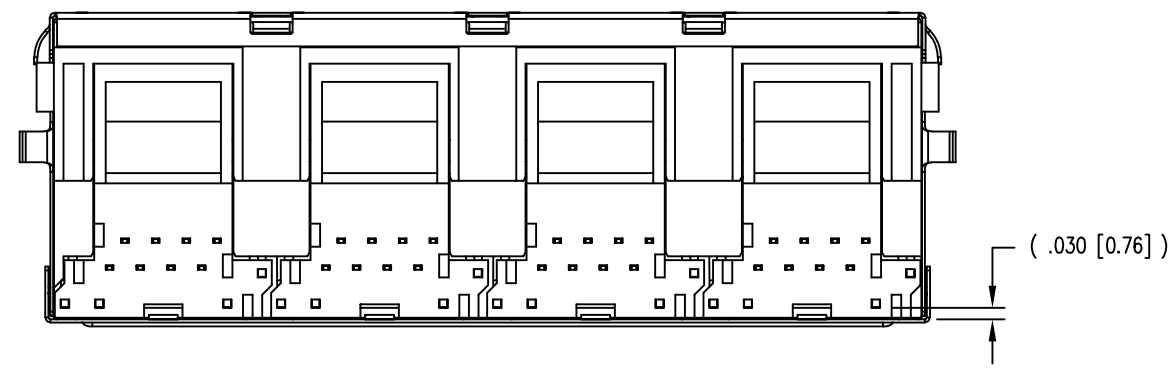
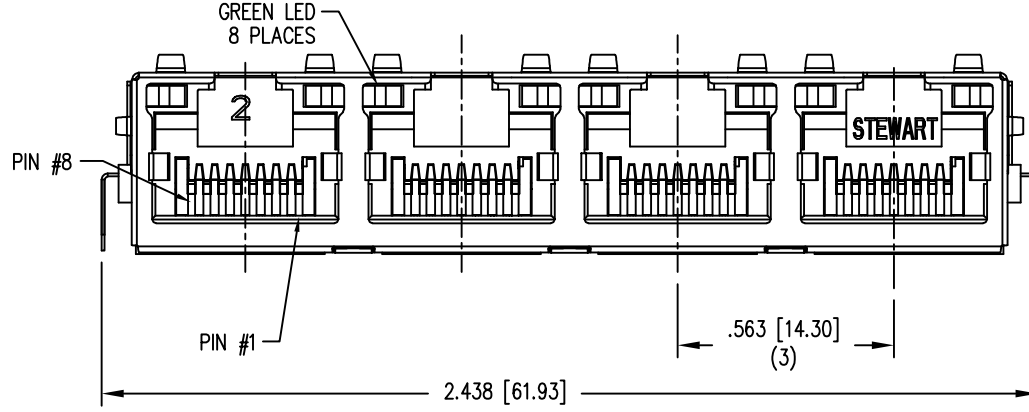

30 MICRO-INCHES [0.76um]	SS-74800-125
CONTACT PLATING IN MATING AREA	PART NUMBER

THIRD ANGLE PROJECTION	 1118 Susquehanna Trail South Glen Rock, PA 17327-9199 (717) 235-7512 http://www.stewartconnector.com
DO NOT SCALE DRAWING DRAWING IS SUBJECT TO CHANGE WITHOUT NOTICE	
DIMENSIONS: INCHES [METRIC]	TITLE: 4 PORT, MID PLANE, LED, JACK, .105" SIGNAL TAILS HALOGEN FREE MATERIAL
UNLESS OTHERWISE SPECIFIED TOLERANCES ARE ±.005 [0.13] ANGLES ARE ± 1°	DRN BY: DHG DATE 3-04-16
SHEET NO. 1 OF 2	APPD BY: TRM DATE 3-04-16
	DWG NO. CT740234 REV. A2



REV. 6/3/05

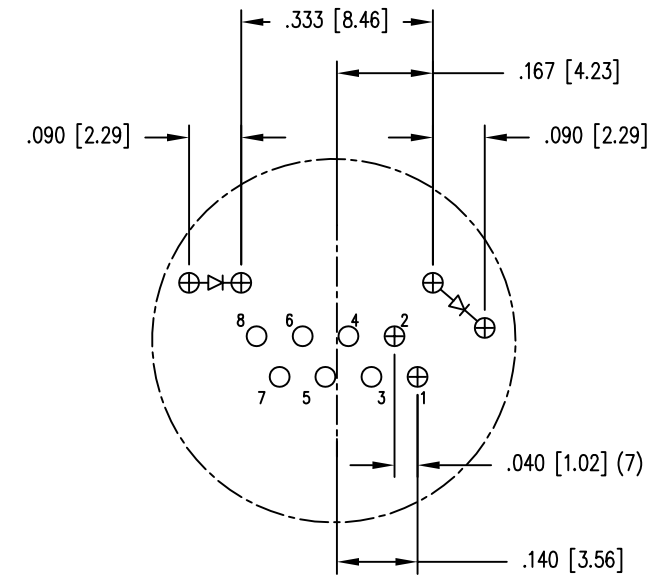
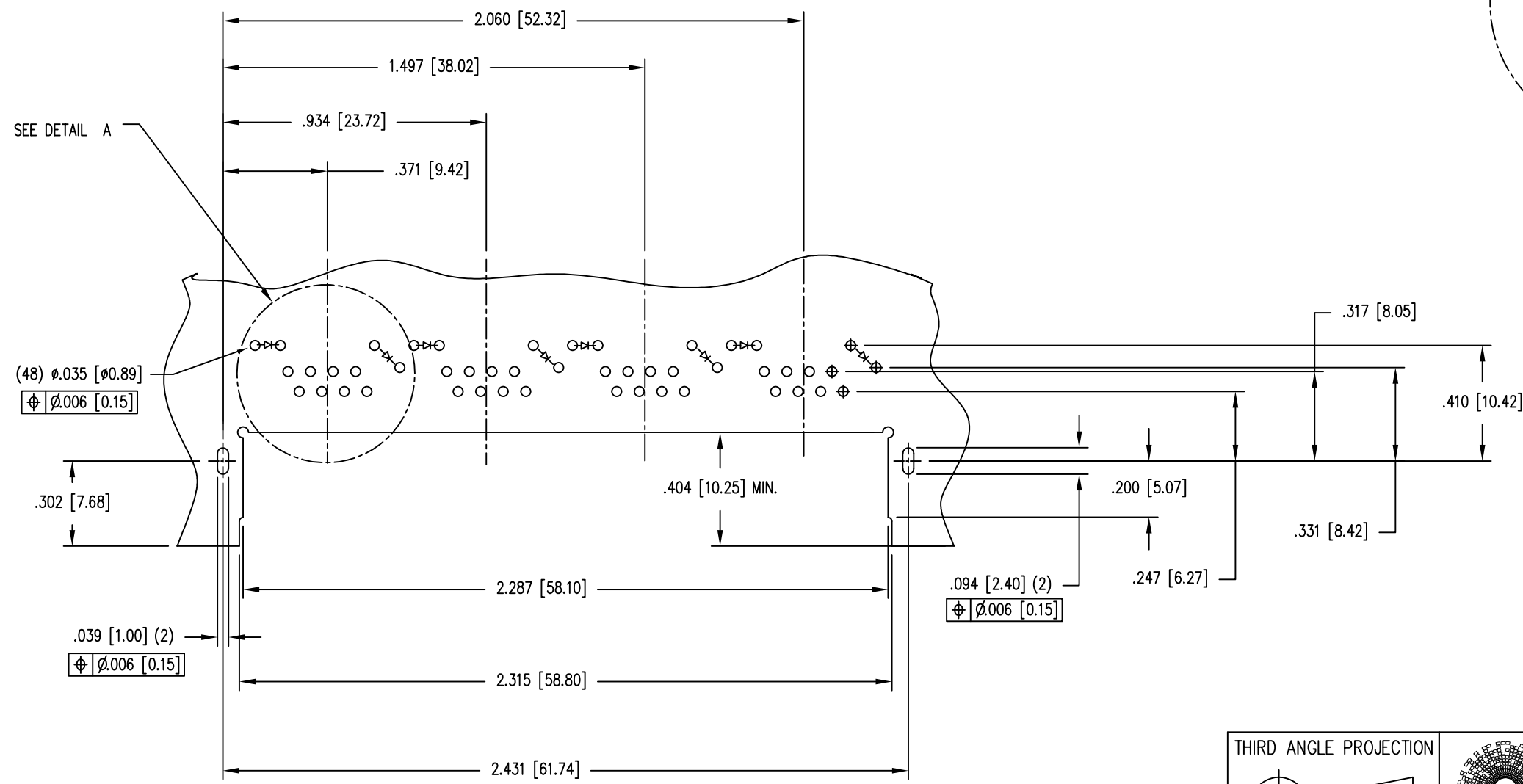

DETAIL A
TYPICAL (4 PLACES)
HOLE LAYOUT

P.C.B. RECOMMENDED HOLE LAYOUT
SEEN FROM COMPONENT SIDE
ALL CENTERLINE DIMENSIONS ARE BASIC.

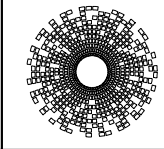
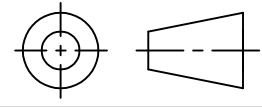

THIRD ANGLE PROJECTION		 stewart CONNECTOR a bel group	1118 Susquehanna Trail South Glen Rock, PA 17327-9199 (717) 235-7512 http://www.stewartconnector.com	
			TITLE: 4 PORT, MID PLANE, LED, JACK, .105" SIGNAL TAILS HALOGEN FREE MATERIAL	
DO NOT SCALE DRAWING DRAWING IS SUBJECT TO CHANGE WITHOUT NOTICE		THIS DRAWING AND THE SUBJECT MATTER SHOWN THEREON ARE CONFIDENTIAL AND THE PROPRIETARY PROPERTY OF STEWART CONNECTOR AND SHALL NOT BE REPRODUCED, COPIED, OR USED IN ANY MANNER WITHOUT PRIOR WRITTEN CONSENT OF STEWART CONNECTOR. ONE OR MORE U.S. PATENTS MAY APPLY TO THIS PRODUCT. FOR DETAILS, PLEASE VISIT: HTTP://BELFUSE.COM/STEWART/STEWART_PATENTS/		
DIMENSIONS: INCHES [METRIC]		DRN BY: DHG	DATE: 3-04-16	
UNLESS OTHERWISE SPECIFIED TOLERANCES ARE ±.005 [0.13] ANGLES ARE ± 1°		APPD BY: TRM	DATE: 3-04-16	
SHEET NO. 2 OF 2		DWG NO. CT740234	REV. A2	