

# PFS1200-12-054xA

## AC-DC Front End Power Supply

The PFS1200-12-054xA is a 1200 Watt AC to DC power-factor-corrected (PFC) power supply that converts standard AC or HVDC power into a main output of 12 VDC for powering intermediate bus architectures (IBA) in high performance and reliability servers, routers, and network switches.

Displays the CE-Mark for the European Low Voltage Directive (LVD).

### KEY FEATURES

- Digital inrush current control
- High Efficiency
  - Meets 80Plus Platinum efficiency requirement
- Universal input voltage range: 90 – 305 VAC
- High voltage DC input: 180 – 400 VDC
- Always-On standby output (model dependent):
  - 3.3 V
  - Programmable 5 V / 12 V
- Hot-plug capable
- Parallel operation with active current sharing
- Digital controls for improved performance
- High density design: 39 W/in<sup>3</sup>
- Dimensions (W x H x L): 54.5 x 40 x 228.6 mm (2.15 x 1.57 x 8.98 in)
- I2C communication interface for control, programming and monitoring with Power Management Bus protocol and PSMI Protocol
- Over temperature, output over voltage and overcurrent protection
- 256 Bytes of EEPROM for user information
- 2 Status LEDs represent Input and Output status

### APPLICATIONS

- High Performance Servers
- Routers
- Switches



## 1. ORDERING INFORMATION

PFS	1200	-	12	-	054	x	A	x
Product Family	Power Level	Dash	V1 Output	Dash	Width	Airflow <sup>1</sup>	Input	Options
PFS Front-Ends	1200 W		12 V		54 mm	N: Normal R: Reverse	A: AC Input	blank: C14 Socket <sup>2</sup> C: C16 Socket <sup>2</sup> H: HVDC Socket <sup>3</sup>

- <sup>1</sup> N = Normal Airflow from Output connector to Input AC socket;  
R = Reverse Airflow from Input AC socket to Output connector
- <sup>2</sup> C14 / C16 AC input connector, input range 90 ~ 264 VAC and 180 ~ 350 VDC
- <sup>3</sup> Ordering PN: PFS1200-12-054xAH for both AC and HVDC (Anderson 2006G1-BK) input connector, input range is 180 ~ 400 VDC and 90 ~ 305 VAC

## 2. OVERVIEW

The PFS1200-12-054xA AC/DC power supply is with DSP control, high efficient front-end power supply. It incorporates resonance-soft-switching technology and interleaved power trains to reduce component stresses, providing increased system reliability and very high efficiency. With a wide input operational voltage range and minimal derating of output power with input voltage and temperature, the PFS1200-12-054xA power supply maximizes power availability in demanding server, network, and other high availability applications. The supply is fan cooled and ideally suited for integration with a matching airflow paths. Both the PFC stage and DC/DC stage is with DSP control. The DC/DC stage uses soft switching resonant techniques in conjunction with synchronous rectification. An active OR-ing device on the output ensures no reverse load current and renders the supply ideally suited for operation in redundant power systems. The always-on standby output, provides power to external power distribution and management controllers. It is protected with an active OR-ing device for maximum reliability. Status information is provided with front-panel LEDs. In addition, the power supply can be controlled and the fan speed set via the I2C bus. The I2C bus allows full monitoring of the supply, including input and output voltage, current, power, and inside temperatures. The fan speed is adjusted automatically depending on the actual power demand and supply temperature and can be overridden through the I2C bus.

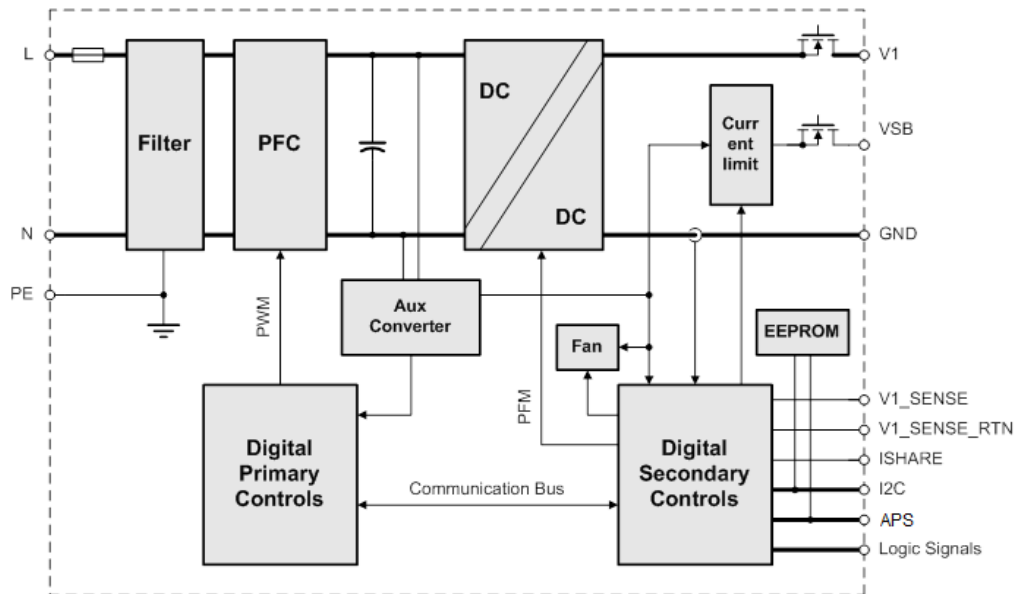

Figure 1. PFS1200-12-054NAH Series Block Diagram

### 3. ABSOLUTE MAXIMUM RATINGS

Stresses in excess of the absolute maximum ratings may cause performance degradation, adversely affect long-term reliability, and cause permanent damage to the supply.

PARAMETER	DESCRIPTION / CONDITION	MIN	NOM	MAX	UNIT
$V_{i\ maxc}$	Maximum Input	Continuous	90	305	VAC

### 4. INPUT SPECIFICATIONS

General Condition:  $T_A = 0 \dots 50^\circ\text{C}$  unless otherwise specified.

PARAMETER	DESCRIPTION / CONDITION	MIN	NOM	MAX	UNIT	
$V_{i\ nom}$	Nominal Input Voltage	100	115/230	277	VAC	
		200		380 <sup>1</sup>	VDC	
$V_i$	Input Voltage Ranges	Normal operating ( $V_{i\ min}$ to $V_{i\ max}$ )		90	305	VAC
				180	400	VDC
$I_{i\ max}$	Max Input Current			16	$A_{rms}$	
$I_{i\ p}$	Inrush Current Limitation	$V_{i\ min}$ to $V_{i\ max}$ , $T_{NTC} = 25^\circ\text{C}$ (Figure 2)		60	$A_p$	
$F_i$	Input Frequency	47	50/60	63	Hz	
$PF$	Power Factor	$V_{i\ nom}$ , 50 Hz, $> 0.3 I_{i\ nom}$		0.94	W/VA	
$V_{i\ on}$	Turn-on Input Voltage <sup>2</sup>	Ramping up		74	84	VAC
				170	180	VDC
$V_{i\ off}$	Turn-off Input Voltage	Ramping down		72	80	VAC
				168	178	VDC
		Input Out of Range		309	314	VAC
				402	410	VDC
$\eta$	Efficiency	$V_{i\ 115VAC}$ , $0.2 \cdot k_{nom}$ , $V_{X\ nom}$ , $T_A = 25^\circ\text{C}$		90		
		$V_{i\ 115\ VAC}$ , $0.5 \cdot k_{nom}$ , $V_{X\ nom}$ , $T_A = 25^\circ\text{C}$		92		
		$V_{i\ 115\ VAC}$ , $k_{nom}$ , $V_{X\ nom}$ , $T_A = 25^\circ\text{C}$		89		
		$V_{i\ 230VAC}$ , $0.2 \cdot k_{nom}$ , $V_{X\ nom}$ , $T_A = 25^\circ\text{C}$		90		
		$V_{i\ 230VAC}$ , $0.5 \cdot k_{nom}$ , $V_{X\ nom}$ , $T_A = 25^\circ\text{C}$		94		
		$V_{i\ 230VAC}$ , $k_{nom}$ , $V_{X\ nom}$ , $T_A = 25^\circ\text{C}$		91		
$T_{hold}$	Hold-up Time	$V_i = 90\text{Vac}$ to $264\ \text{VAC}$ , $V_1 \geq 11.4\ \text{V}$ , Cout = 5000 $\mu\text{F}$ , 80% nominal output power, Time from de-assert INPUT_OK to Vout out of regulation or OUTPUT_OK de-asserts		5	ms	

<sup>1</sup> For PFS1200-12-054NA/ PFS1200-12-054NAC and PFS1200-12-054RA/ PFS1200-12-054RAC, normal DC operation input range is 200 VDC to 350 VDC; normal AC operation input range is 100 VAC ~ 240 VAC.

<sup>2</sup> The Front-End is provided with a minimum hysteresis of 3 V during turn-on and turn-off within the ranges.



#### 4.1 INPUT FUSE

Slow-acting 16 A input fuse (5 x 20 mm) in series the L line inside the power supply protect against severe defects. The fuse is not accessible from the outside and are therefore not serviceable parts.

#### 4.2 INRUSH CURRENT

The AC-DC power supply exhibits low X-capacitance resulting in a low and short peak current, when the supply is connected to the mains. The internal bulk capacitor will be charged through an NTC which will limit the inrush current.

**NOTE:** Do not repeat plug-in / out operations within a short time, or else the internal in-rush current limiting device (NTC) may not sufficiently cool down and excessive inrush current or component failure(s) may result.

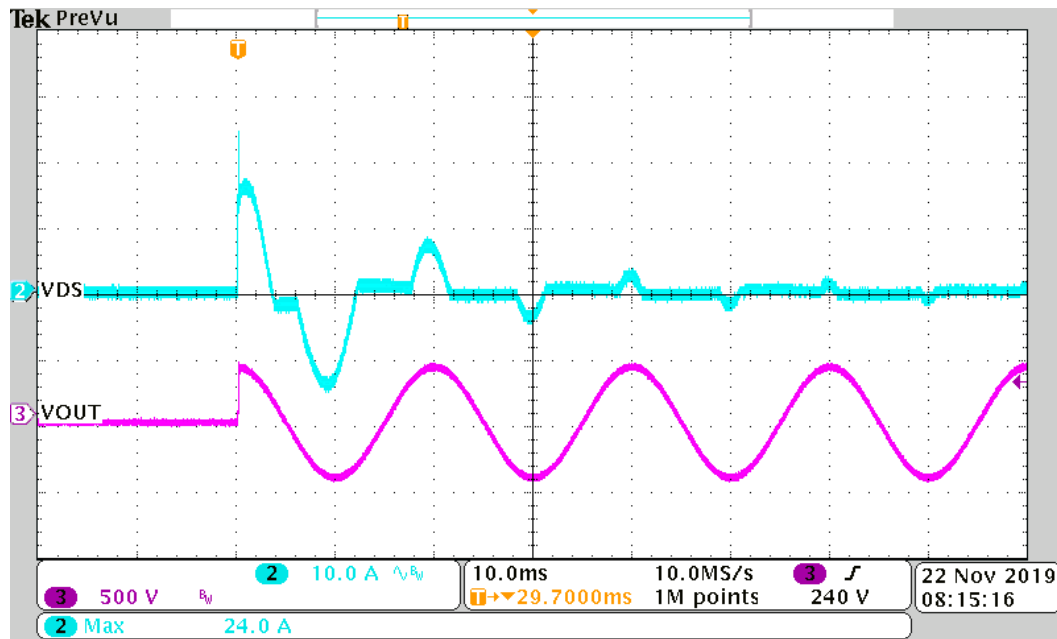

Figure 2. Inrush current,  $V_{in} = 305 \text{ Vac}$ ,  $90^\circ$ , CH3:  $V_{in}$  (500V/div), CH2:  $I_{in}$  (10A/div)

#### 4.3 INPUT UNDER-VOLTAGE

If the sinusoidal input voltage stays below the input under voltage lockout threshold  $V_{i on}$ , the supply will be inhibited. Once the input voltage returns within the normal operating range, the supply will return to normal operation again.

#### 4.4 POWER FACTOR CORRECTION

Power factor correction (PFC) is achieved by controlling the input current waveform synchronously with the input voltage. An analog controller is implemented giving outstanding PFC results over a wide input voltage and load ranges. The input current will follow the shape of the input voltage.

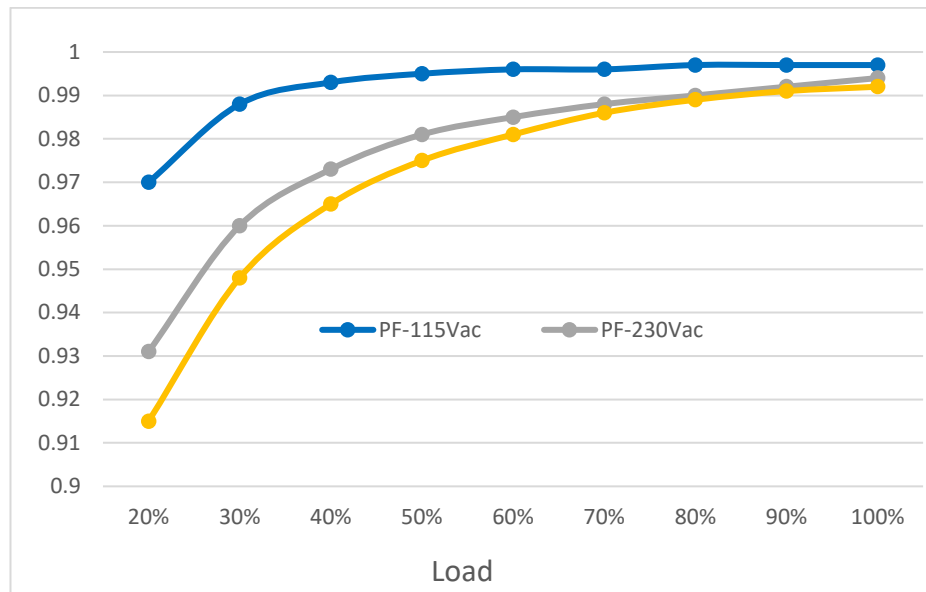

Figure 3. PF vs. Load

#### 4.5 EFFICIENCY

High efficiency is achieved by using state-of-the-art silicon power devices in conjunction with soft-transition topologies minimizing switching losses and a full digital control scheme. Synchronous rectifiers on the output reduce the losses in the high current output path. The speed of the fan is digitally controlled to keep all components at an optimal operating temperature regardless of the ambient temperature and load conditions.

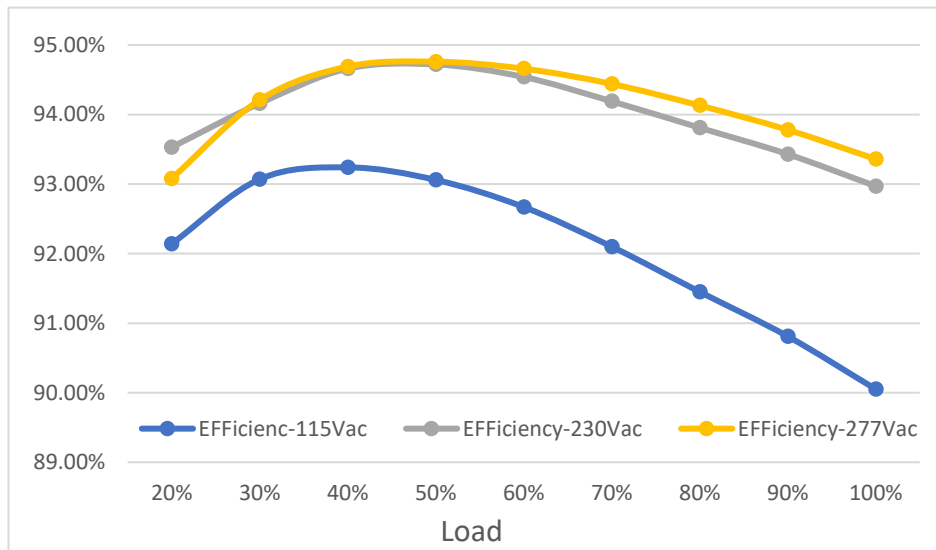

Figure 4. Efficiency vs. Load



## 5. OUTPUT SPECIFICATIONS

General Condition:  $T_a = 0 \dots 50^\circ\text{C}$  unless otherwise specified.

PARAMETER	DESCRIPTION / CONDITION	MIN	NOM	MAX	UNIT	
<b>Main Output <math>V_1</math></b>						
$V_{1\text{ nom}}$	Nominal Output Voltage		12.0		VDC	
$V_{1\text{ set}}$	Output Setpoint Accuracy	$0.5 \cdot I_{\text{nom}}, T_{\text{amb}} = 25^\circ\text{C}$		+0.5	% $V_{1\text{ nom}}$	
$dV_{1\text{ tot}}$	Total Regulation	$V_{1\text{ min}}$ to $V_{1\text{ max}}$ , 0 to 100% $I_{\text{nom}}, T_{\text{a min}}$ to $T_{\text{a max}}$		-2	+2	% $V_{1\text{ nom}}$
$P_{1\text{ nom}}$	Nominal Output Power	305 VAC > $V_{1\text{ in}} \geq 90$ VAC, $V_1 = 12$ VDC	1200		W	
	Refer to <i>Figure 6b</i> for derating curves	400 VDC > $V_{1\text{ in}} \geq 180$ VDC, $V_1 = 12$ VDC	1200		W	
$I_{1\text{ nom}}$	Nominal Output Current	305 VAC > $V_{1\text{ in}} \geq 90$ VAC, $V_1 = 12$ VDC	100		ADC	
		400 VDC > $V_{1\text{ in}} \geq 180$ VDC, $V_1 = 12$ VDC	100		ADC	
$V_{1\text{ pp}}$	Output Ripple Voltage	$V_{1\text{ nom}}$ , 0 to 100% $I_{\text{nom}}$ , 20 MHz BW (See Section 5.1)		120	mVpp	
$dV_{1\text{ Load}}$	Load Regulation	$V_1 = V_{1\text{ nom}}$ , 0 - 100 % $I_{\text{nom}}$	80		mV	
$dV_{1\text{ Line}}$	Line Regulation	$V_1 = V_{1\text{ min}} \dots V_{1\text{ max}}$	40		mV	
$dI_{\text{share}}$	Current Sharing	Deviation from $I_{\text{tot}} / N$ , $I_1 > 10\%$	-3	+3	A	
$dV_{\text{dyn}}$	Dynamic Load Regulation	$\Delta I = 50\% I_{\text{nom}}$ , $I_1 = 10 \dots 100\% I_{\text{nom}}$ , $dI/dt = 1\text{A}/\mu\text{s}$	-0.6	0.6	V	
$T_{\text{rec}}$	Recovery Time	$\Delta I = 50\% I_{\text{nom}}$ , $I_1 = 10 \dots 100\% I_{\text{nom}}$ , $dI/dt = 1\text{A}/\mu\text{s}$ , recovery within 1% of $V_{1\text{ nom}}$		2	ms	
$t_{\text{AC } V_1}$	Start-up Time from AC			3	sec	
$t_{V_1\text{ rise}}$	Rise Time	$V_1 = 10 \dots 90\% V_{1\text{ nom}}$	0.5	10	ms	
$C_{\text{Load}}$	Capacitive Loading	$T_a = 25^\circ\text{C}$	1000	20000	$\mu\text{F}$	
<b>3.3/5 V<sub>SB</sub> Standby Output</b>						
$V_{\text{SB nom}}$	Nominal Output Voltage	V <sub>SB_SEL1</sub> = 1	3.3		VDC	
		V <sub>SB_SEL2</sub> = 1	5.0		VDC	
$V_{\text{SB set}}$	Output Setpoint Accuracy	$0.5 \cdot I_{\text{SB nom}}, T_{\text{amb}} = 25^\circ\text{C}$		+0.5	% $V_{1\text{ nom}}$	
$dV_{\text{SB tot}}$	Total Regulation	$V_{1\text{ min}}$ to $V_{1\text{ max}}$ , 0 to 100% $I_{\text{SB nom}}, T_{\text{a min}}$ to $T_{\text{a max}}$		-5	+5	% $V_{\text{SB nom}}$
$P_{\text{SB nom}}$	Nominal Output Power	$V_{\text{SB}} = 3.3$ VDC	16.5		W	
		$V_{\text{SB}} = 5.0$ VDC	16.5		W	
$I_{\text{SB nom}}$	Nominal Output Current	$V_{\text{SB}} = 3.3$ VDC	5		ADC	
		$V_{\text{SB}} = 5.0$ VDC	3.3		ADC	
$V_{\text{SB pp}}$	Output Ripple Voltage	$V_{\text{SB nom}}, I_{\text{SB nom}}$ , 20 MHz BW (See Section 5.1)		50	mVpp	
$I_{\text{SB max}}$	Current Limitation	V <sub>SB_SEL1</sub> = 1, V <sub>SB_SEL2</sub> = 1	5.25	6.5	ADC	
		V <sub>SB_SEL1</sub> = 0, V <sub>SB_SEL2</sub> = 1	3.45	4.3	ADC	
$dV_{\text{SB dyn}}$	Dynamic Load Regulation	$\Delta I_{\text{SB}} = 50\% I_{\text{SB nom}}, I_{\text{SB}} = 5 \dots 100\% I_{\text{SB nom}}$ , $dI/dt = 0.5\text{A}/\mu\text{s}$ , recovery within 1% of $V_{1\text{ nom}}$	-5	5	% $V_{\text{SB nom}}$	
$T_{\text{rec}}$	Recovery Time			250	$\mu\text{s}$	
$t_{\text{AC VSB}}$	Start-up Time from AC	$V_{\text{SB}} = 90\% V_{\text{SB nom}}$		2	sec	
$t_{\text{VSB rise}}$	Rise Time	$V_{\text{SB}} = 10 \dots 90\% V_{\text{SB nom}}$	0.5	30	ms	
$C_{\text{Load}}$	Capacitive Loading	$T_{\text{amb}} = 25^\circ\text{C}$	100	1,500	$\mu\text{F}$	

12 V <sub>SB</sub> Standby Output						
V <sub>SB nom</sub>	Nominal Output Voltage	0.5 · I <sub>SB nom</sub> , T <sub>amb</sub> = 25°C	V <sub>SB_SEL1</sub> = 1	12		VDC
V <sub>SB set</sub>	Output Setpoint Accuracy		V <sub>SB_SEL2</sub> = 0	-1	+1	% V <sub>SB nom</sub>
dV <sub>SB tot</sub>	Total Regulation	V <sub>I min</sub> to V <sub>I max</sub> , 0 to 100% I <sub>SB nom</sub> , T <sub>a min</sub> to T <sub>a max</sub>		-5	+5	% V <sub>SB nom</sub>
P <sub>SB nom</sub>	Nominal Output Power	I <sub>SB</sub> = 12 VDC		24		W
I <sub>SB nom</sub>	Nominal Output Current	V <sub>SB</sub> = 12 VDC		2		A
V <sub>SB pp</sub>	Output Ripple Voltage	I <sub>SB nom</sub> , I <sub>SB nom</sub> , 20 MHz BW (See Section 5.1)		120		mVpp
I <sub>SB max</sub>	Current Limitation			2.1	2.6	ADC
dV <sub>SB dyn</sub>	Dynamic Load Regulation	ΔI <sub>SB</sub> = 50% I <sub>SB nom</sub> , I <sub>SB</sub> = 5 ... 100% I <sub>SB nom</sub> , dI/dt = 1 A/μs, recovery within 1% of V <sub>I min</sub>		-0.6	0.6	V
T <sub>rec</sub>	Recovery Time			2		ms
t <sub>AC VSB</sub>	Start-up Time from AC	I <sub>SB</sub> = 90% I <sub>SB nom</sub>		2		s
t <sub>VB rise</sub>	Rise Time	I <sub>SB</sub> = 10...90% I <sub>SB nom</sub>		20		ms
C <sub>load</sub>	Capacitive Loading	T <sub>amb</sub> = 25°C		100	1,500	μF

### 5.1 OUTPUT VOLTAGE RIPPLE

Internal capacitance at the 12 V output (behind the OR-ing circuitry) is minimized to prevent disturbances during hot plug. In order to provide low output ripple voltage in the application, external capacitors (a parallel combination of 10 μF low ESR capacitor in parallel with 0.1 μF ceramic capacitors) should be added close to the power supply output. The setup of Figure 5 has been used to evaluate suitable capacitor types. The capacitor combinations of Table 1 and Table 2 should be used to reduce the output ripple voltage. The ripple voltage is measured with 20 MHz BWL, close to the external capacitors.

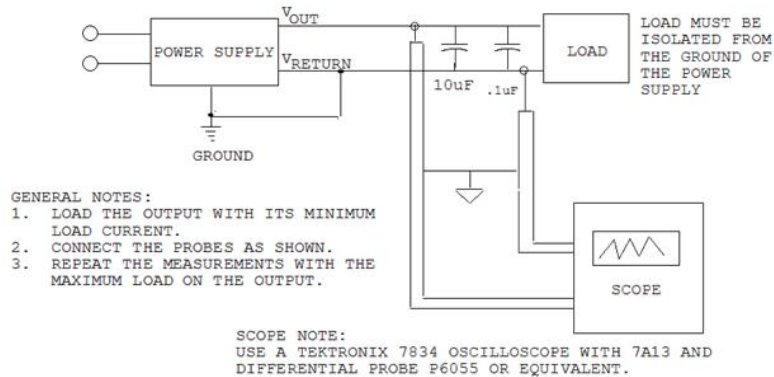

Figure 5. Output ripple test setup

**NOTE:** Care must be taken when using ceramic capacitors with a total capacitance of 1 μF to 50 μF on output V1, due to their high quality factor the output ripple voltage may be increased in certain frequency ranges due to resonance effects.

EXTERNAL CAPACITOR V1	DV1MAX	UNIT
Standard test condition:		
1 Pc 10 μF / min 16 V low ESR Capacitor	120	mVpp
1 pc 0.1 μF / 50 V ceramic capacitor		

Table 1. Suitable capacitors for V1

EXTERNAL CAPACITOR VSB	DV1MAX	UNIT
Standard test condition:		
1 pc 10 μF / min 16 V low ESR Capacitor	120	mVpp
1 pc 0.1 μF / 50V ceramic capacitor		

Table 2. Suitable capacitors for V<sub>SB</sub>



Asia-Pacific  
+86 755 298 85888

Europe, Middle East  
+353 61 49 8941

North America  
+1 866 513 2839

The output ripple voltage on  $V_{SB}$  is influenced by the main output  $V_1$ . Evaluating  $V_{SB}$  output ripple must be done when maximum load is applied to  $V_1$ .

## 6. PROTECTION SPECIFICATIONS

PARAMETER	DESCRIPTION / CONDITION	MIN	NOM	MAX	UNIT	
$F$	Input Fuse (L)	Not user accessible		16	A	
$V_1_{OV}$	OV Threshold $V_1$	13.3		14.5	VDC	
$t_{OV V1}$	OV Latch Off Time $V_1$			1	ms	
$V_{SB OV}$	OV Threshold $V_{SB}$	110%		120%	VDC	
$t_{OV VSB}$	OV Latch Off Time $V_{SB}$		1		ms	
$I_{1 lim}$	Over Current Limitation $V_1$	$V_1 > 90 VAC, T_a < 50^\circ C$		140	A	
$I_{VSB lim}$	Over Current Limitation $V_{SB}$	$T_a < 50^\circ C$ for $12V_{SB}$		2.6	A	
		$T_a < 50^\circ C$ for $5V_{SB}$		4.3	A	
		$T_a < 50^\circ C$ for $3.3V_{SB}$		6.5	A	
$t_{V1 SC}$	Short Circuit Regulation Time	$V_1 < 3 V$ , time until $I_{V1}$ is limited to $< 200 A$		2	ms	
$T_{SD}$	Over Temperature on Heat Sinks	Automatic shut-down		115	120	$^\circ C$

### 6.1 OVERVOLTAGE PROTECTION

The PFS front-ends provide a fixed threshold overvoltage (OV) protection implemented with a HW comparator. Once an OV condition has been triggered, the supply will shut down and latch the fault condition. The latch can be unlocked by disconnecting the supply from the AC mains or by toggling the PSON\_L input

### 6.2 UNDERVOLTAGE DETECTION

Both main and standby outputs are monitored. LED and PWOK\_L pin signal if the output voltage exceeds  $\pm 7\%$  of its nominal voltage. Output under voltage protection is provided on both outputs. When either  $V_1$  or  $V_{SB}$  falls below 93% of its nominal voltage, the output is inhibited.

### 6.3 CURRENT LIMITATION

#### 6.3.1 MAIN OUTPUT

When main output runs in current limitation mode its output will turn OFF below 2 V but will shut down after 6 attempts. If current limitation mode is still present after the unit retry, output will continuously perform this routine until current is below the current limitation point. The supply will go through soft start every time it retries from current limitation mode.

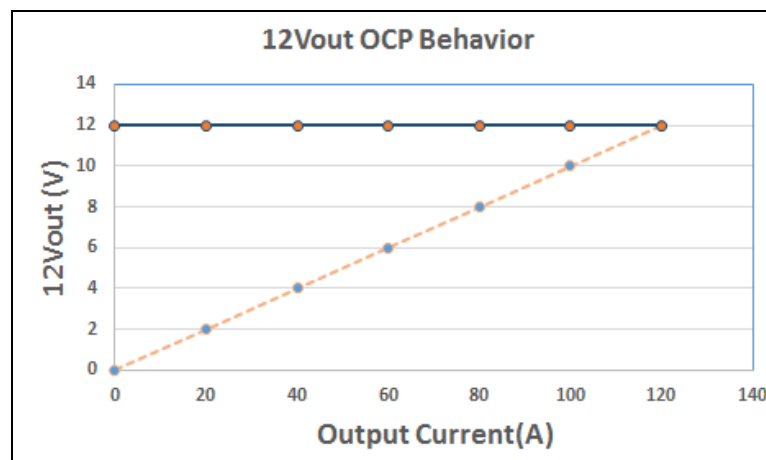



Figure 6a. Current Limitation on  $V_i$  ( $V_i = 230 \text{ VAC}$ )

The output power derating of V1 refers to Figure 6b Ambient Derating Curve.

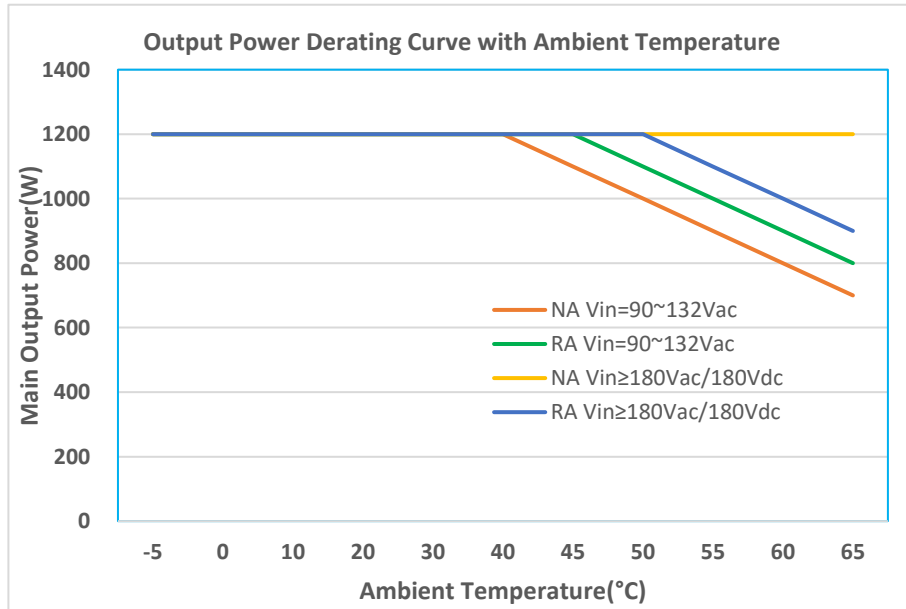

Figure 6b. Ambient Derating Curve

Note:

1. NA: Normal Airflow RA: Reverse Airflow Refer to Figure 21.
2. The application of power supply should also refer to installation instructions document
3. The power supply has no limitation on its output current/power in respect of meeting the operating conditions shown by the derating limits shown above. It is the responsibility of the end user to ensure operating conditions are maintained within their safety agency certification limits to assure safe and reliable operation.

### 6.3.2 STANDBY OUTPUT

#### 3.3 / 5 $V_{sb}$

The standby output exhibits a substantially rectangular output characteristic down to 0 V (no hiccup mode / latch off). If it runs in current limitation and its output voltage drops below the UV threshold, then the main output will be inhibited (standby remains on). The current limitation of the standby output is independent of the AC input voltage.

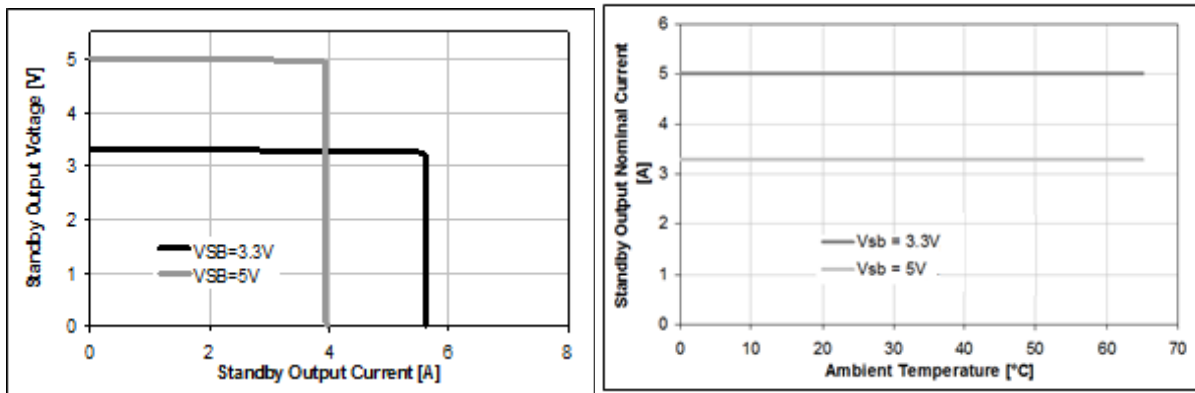
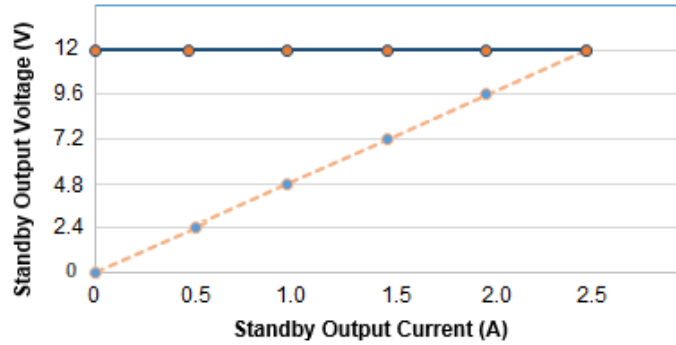

Figure 7. Current Limitation and Temperature Derating on 3.3/5 V<sub>SB</sub>**12 V<sub>SB</sub>**

On the standby output, a hiccup type over current protection is implemented. This protection will shut down the standby output immediately when standby current reaches or exceeds  $I_{SB\ lim}$ . After an off-time of 1 s the output automatically tries to restart. If the overload condition is removed the output voltage will reach again its nominal value. At continuous overload condition the output will repeatedly trying to restart with 1s intervals. A failure on the Standby output will shut down both Main and Standby outputs.

Figure 8. Current Limitation on 12 V<sub>SB</sub>**7. MONITORING**

PARAMETER	DESCRIPTION / CONDITION	MIN	NOM	MAX	UNIT
$V_{i\ mon}$	Input RMS Voltage $V_{i\ min} \leq V_i \leq V_{i\ max}$	-2.5		+2.5	%
$I_{i\ mon}$	Input RMS Current $I_i > 2\ A_{rms}$	-5		+5	%
$P_{i\ mon}$	True Input Power $I_i > 2\ A_{rms}$	-5		+5	%
$V_{1\ mon}$	V <sub>1</sub> Voltage	-2		+2	%
$I_{1\ mon}$	V <sub>1</sub> Current	$I_1 > 25\ A$	-2	+2	%
		$I_1 \leq 25\ A$	-1	+1	A
$P_{o\ nom}$	Total Output Power	$P_o > 120\ W$	-5	+5	%
		$P_o \leq 120\ W$	-12	+12	W
$V_{SB\ mon}$	Standby Voltage	-0.5		+0.5	V
$I_{SB\ mon}$	Standby Current $I_{SB} \leq I_{SB\ nom}$	-0.5		+0.5	A

## 8. SIGNAL & CONTROL SPECIFICATIONS

### 8.1 ELECTRICAL CHARACTERISTICS

PARAMETER	DESCRIPTION / CONDITION	MIN	NOM	MAX	UNIT
<b>PSKILL_H / PSON_L / HOTSTANDBYEN_H Inputs</b>					
$V_L$	Input Low Level Voltage	-0.2		0.8	V
$V_H$	Input High Level Voltage	2.4		3.5	V
$I_{L,H}$	Maximum Input Sink or Source Current	0		1	mA
$R_{puPSKILL\_H}$	Internal Pull Up Resistor on PSKILL_H		20		kΩ
$R_{puPSON\_L}$	Internal Pull Up Resistor on PSON_L		10		kΩ
$R_{puHOTSTANDBYEN\_H}$	Internal Pull Up Resistor on HOTSTANDBYEN_H		2		kΩ
$R_{LOW}$	Resistance Pin to SGND for Low Level	0		1	kΩ
$R_{HIGH}$	Resistance Pin to SGND for High Level	50			kΩ
<b>PWOK_H Output</b>					
$V_{OL}$	Output Low Level Voltage			0.4	V
				$I_{sink} < 4 \text{ mA}$	
$V_{OH}$	Output High Level Voltage	2.6		3.5	V
				$I_{source} < 0.5 \text{ mA}$	
$R_{puPWOK\_H}$	Internal Pull Up Resistor on PWOK_H		1		kΩ
<b>ACOK_H Output</b>					
$V_{OL}$	Output Low Level Voltage			0.4	V
				$I_{sink} < 2 \text{ mA}$	
$V_{OH}$	Output High Level Voltage	2.6		3.5	V
				$I_{source} < 50 \text{ μA}$	
$R_{puACOK\_H}$	Internal Pull Up Resistor on ACOK_H		1		kΩ
<b>SMB_ALERT_L Output</b>					
$V_{ext}$	Maximum External Pull Up Voltage			12	V
$V_{OL}$	Output Low Level Voltage			0.4	V
				$I_{source} < 4 \text{ mA}$	
$I_{OH}$	Maximum High Level Leakage Current			10	μA
$R_{puSMB\_ALERT\_L}$	Internal Pull Up Resistor on SMB_ALERT_L		None		kΩ

### 8.2 INTERFACING WITH SIGNALS

All signal pins have protection diodes implemented to protect internal circuits. When the power supply is not powered, the protection devices start clamping at signal pin voltages exceeding  $\pm 0.5 \text{ V}$ . Therefore, all input signals should be driven only by an open collector/drain to prevent back feeding inputs when the power supply is switched off. If interconnecting of signal pins of several power supplies is required, then this should be done by decoupling with small signal schottky diodes except for SMB\_ALERT\_L, ISHARE and I<sup>2</sup>C pins. SMB\_ALERT\_L pins can be interconnected without decoupling diodes, since these pins have no internal pull up resistor and use a 15 V zener diode as protection device against positive voltage on pins. ISHARE pins must be interconnected without any additional components. This in-/output is disconnected from internal circuits when the power supply is switched off.

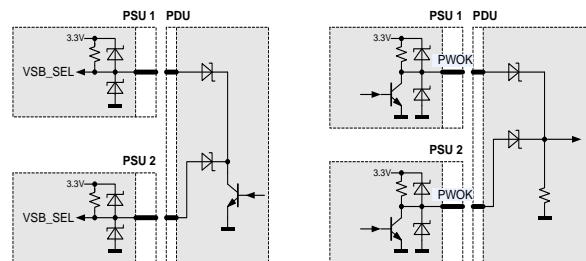

Figure 9. Interconnection of Signal Pins



### 8.3 FRONT LEDS

There are two Bi-color (Green/ Amber) LEDs to indicate power supply status. The LEDs are visible on the power supply's front panel. The LEDs location meets ESD Requirements. Following are these definitions as:

LED FUNCTION	COLOR	BRIGHTNESS	
Input Status LED	Green (520 nm – 540 nm) / (Amber color not used)	500-1000cd/m <sup>2</sup>	
Output Status LED	Green (520 nm – 540 nm) / Amber (520 nm – 540 nm) Amber (587 nm – 595 nm)	500-1000cd/m <sup>2</sup>	

OPERATING CONDITION	LED BEHAVIOR		
	CONDITION	INPUT STATUS LED	OUTPUT STATUS LED
Output ON and OK		GREEN Solid	GREEN Solid
No Input power to all power supplies		OFF	OFF
Power supply warning events where the power supply continues to operate: high temp, high power, high current, over voltage, under voltage, slow fan.		GREEN Solid	1Hz AMBER/GREEN Blinking
Power supply critical event causing a shutdown: failure, OCP, SCP, OVP, UVP, OTP, Fan Fail		GREEN Solid	AMBER Solid
Input over voltage shutdown		1Hz GREEN Blinking	AMBER Solid
Input under voltage shutdown		1Hz GREEN Blinking	OFF
PS_KILL		GREEN Solid	OFF
Input present / Only 12VSB on (PS off)		GREEN Solid	1Hz Blinking GREEN
Power supply in FW upload mode		GREEN Solid	2Hz Blinking GREEN

AMBER/GREEN BLINKING: means AMBER and GREEN LED flash alternately.

Table 3. LED Status

### 8.4 PRESENT\_L

This signaling pin is recessed within the connector and will contact only once all other connector contacts are closed. This active-low pin is used to indicate to a power distribution unit controller that a supply is plugged in. The maximum current on PRESENT\_L pin should not exceed 10 mA.



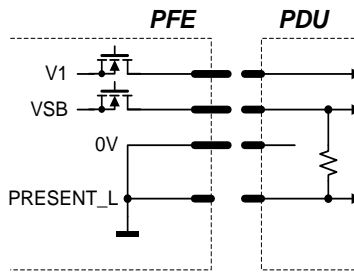

Figure 10. PRESENT\_L signal pin

### 8.5 PSKILL\_H INPUT

The PSKILL\_H input is active-high and is located on a recessed pin on the connector and is used to disconnect the main output as soon as the power supply is being plugged out. This pin should be connected to SGND in the power distribution unit. The standby output will remain on regardless of the PSKILL\_H input state.

### 8.6 AC TURN-ON / DROP-OUTS / ACOK\_H

The power supply will automatically turn-on when connected to the AC line under the condition that the PSON\_L signal is pulled low and the AC line is within range. The ACOK\_H signal is active-high. See the timing diagram, Figure 11 and Table 4.

OPERATING CONDITION		MIN	MAX	UNIT
$t_{AC\ VSB}$	AC Line to 90% $V_{SB}$		2	sec
$t_{AC\ V1}$	AC Line to 90% $V_1$		2	sec
$t_{ACOK\_H\ on1}$	ACOK_H signal on delay (start-up)		2000	ms
$t_{ACOK\_H\ on2}$	ACOK_H signal on delay (dips)		100	ms
$t_{ACOK\_H\ off}$	ACOK_H signal off delay		5	ms
$t_{VSB\ V1\ del}$	$V_{SB}$ to $V_1$ delay	10	500	ms
$t_{V1\ holdup}$	Effective $V_1$ holdup time	5		ms
$t_{VSB\ holdup}$	Effective $V_{SB}$ holdup time	20		ms
$t_{ACOK\_H\ V1}$	ACOK_H to $V_1$ holdup	5		ms
$t_{ACOK\_H\ VSB}$	ACOK_H to $V_{SB}$ holdup	15		ms
$t_{V1\ off}$	Minimum $V_1$ off time	1	2	sec
$t_{VSB\ off}$	Minimum $V_{SB}$ off time	1	2	sec

NOTE: AC short dips means below 10 ms;  
AC long dips means 10 ms to 100 ms

Table 4. AC Turn-on / Dip Timing

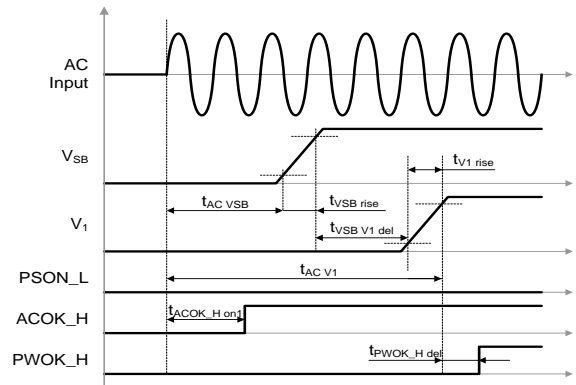

Figure 11. AC turn-on timing



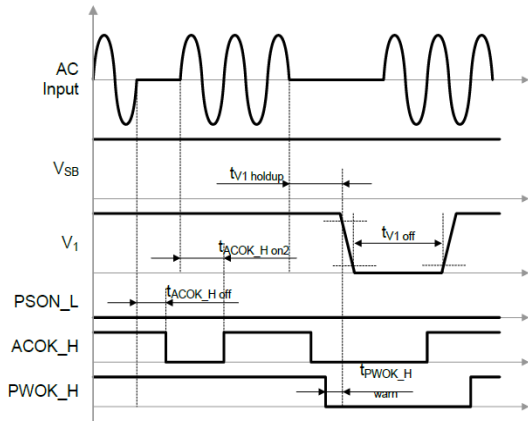

Figure 12. AC short dips

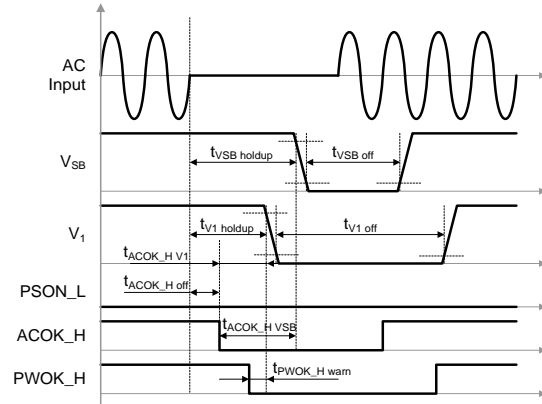

Figure 13. AC long dips

### 8.7 PSON\_L INPUT

The PSON\_L is an internally pulled-up (3.3 V) input signal to enable/disable the main output V1 of the front-end. This active-low pin is also used to clear any latched fault condition, see the parameters in Table 5.

OPERATING CONDITION		MIN	MAX	UNIT
$t_{\text{PSON\_L V1on}}$	PSON_L to V1 delay (on)	2	20	ms
$t_{\text{PSON\_L V1off}}$	PSON_L to V1 delay (off)	2	20	ms
$t_{\text{PSON\_L H min}}$	PSON_L minimum High time	10		ms

Table 5. PSON\_L timing

### 8.8 PWOK\_H SIGNAL

The PWOK\_H is an open drain output with an internal pull-up to 3.3 V indicating whether both Vsb and V1 outputs are within regulation. This pin is active-low. The timing diagram is shown in Figure 14 and referenced in the Table 6.

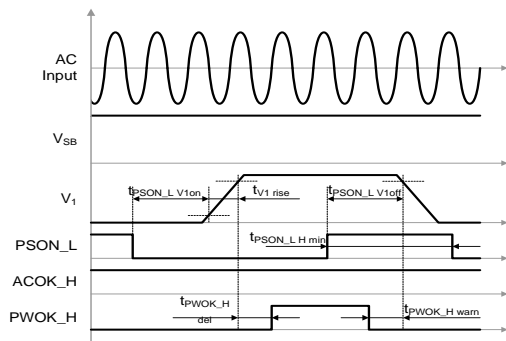

Figure 14. PSON\_L and PWOK\_H turn-on/off timing

OPERATING CONDITION		MIN	MAX	UNIT
$t_{\text{PWOK\_H del}}$	PWOK_H to V1 delay (on)	100	500	ms
$t_{\text{PWOK\_H warn}}^*$	PWOK_H to V1 delay (off) caused by:			
	PSKILL_H	0	1	ms
	PSON_L, OT, Fan Failure	0.5	5	ms
	ACOK_H (time change with loading condition)	0.5	100	ms
	UV and OV on VSB	1	30	ms
	OC on V1 (Software trigger)	-11	0	ms
	OC on V1 (Hardware trigger)	-1	0	ms
	OV on V1	-3	0	ms

\* A positive value means a warning time, a negative value a delay (after fact).

Table 6. PWOK\_H timing



## 8.9 VSB VOLTAGE SELECTION (VSB\_SEL1, VSB\_SEL2)

The standby output voltage can be configured to three different values: 3.3 V, 5 V and 12 V by pulling VSB\_SEL1 and VSB\_SEL2 input pins either to GND (Logic Low) or to 3.3 V

VSB_SEL1	VSB_SEL2	VSB Voltage	UNIT
1	1	3.3	V
0	1	5	V
1	0	12	V
0	0	Invalid (Off)	

Table 7. VSB Voltage selection

## 8.10 CURRENT SHARE

The PFS front-ends have an active current share scheme implemented for  $V_1$ . All the ISHARE current share pins need to be interconnected in order to activate the sharing function. If a supply has an internal fault or is not turned on, it will disconnect its ISHARE pin from the share bus. This will prevent dragging the output down (or up) in such cases.

The current share function uses a analog bi-directional data exchange on a recessive bus configuration to transmit and receive current share information. The controller implements a Master/Slave current share function. The power supply providing the largest current among the group is automatically the Master. The other supplies will operate as Slaves and increase their output current to a value close to the Master by slightly increasing their output voltage. The voltage increase is limited to +250 mV.

The standby output uses a passive current share method (droop output voltage characteristic).

## 8.11 SENSE INPUTS

Main output has sense lines implemented to compensate for voltage drop on load wires (no sense lines for 12VSB). The maximum allowed voltage drop is 200 mV on the positive rail and 100 mV on the PGND rail.

With open sense inputs the main output voltage will rise by 270 mV. Therefore, if not used, these inputs should be connected to the power output and PGND close to the power supply connector. The sense inputs are protected against short circuit. In this case the power supply will shut down.

## 8.12 HOT-STANDBY OPERATION

The hot-standby operation is an operating mode allowing to further increase efficiency at light load conditions in a redundant power supply system. Under specific conditions one of the power supplies is allowed to disable its DC/DC stage. This will save the power losses associated with this power supply and at the same time the other power supply will operate in a load range having a better efficiency. In order to enable the hot standby operation, the HOTSTANDBYEN\_H and the ISHARE pins need to be interconnected. A power supply will only be allowed to enter the hot-standby mode, when the HOTSTANDBYEN\_H pin is high, the load current is low and the supply was allowed to enter the hot-standby mode by the system controller via the appropriate I<sup>2</sup>C command (by default disabled). The system controller needs to ensure that only one of the power supplies is allowed to enter the hot-standby mode.

If a power supply is in a fault condition, it will pull low its active-high HOTSTANDBYEN\_H pin which indicates to the other power supply that it is not allowed to enter the hot-standby mode or that it needs to return to normal operation should it already have been in the hot-standby mode.

**NOTE:** The system controller needs to ensure that only one of the power supplies is allowed to enter the hot-standby model.



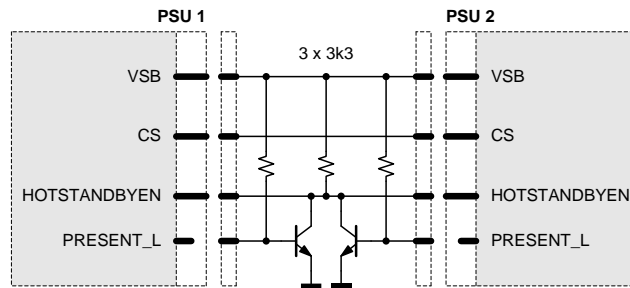

Figure 15. Recommended hot-standby configuration

In order to prevent voltage dips when the active power supply is unplugged while the other is in hot-standby mode, it is strongly recommended to add the external circuit as shown in 15. If the PRESENT\_L pin status needs also to be read by the system controller, it is recommended to exchange the bipolar transistors with small signal MOS transistors or with digital transistors.

### 8.13 I2C / SMBUS COMMUNICATION

The interface driver in the PFS supply is referenced to the V1 Return. The PFS supply is a communication Slave device only; it never initiates messages on the I2C/SMBus by itself. The communication bus voltage and timing is defined in Table 8 further characterized through:

- There are no internal pull-up resistors
- The SDA/SCL IOs are 3.3/5 V tolerant
- Full SMBus clock speed of 100 kbps
- Clock stretching limited to 1 ms
- SCL low time-out of >25 ms with recovery within 10 ms
- Recognizes any time Start/Stop bus conditions

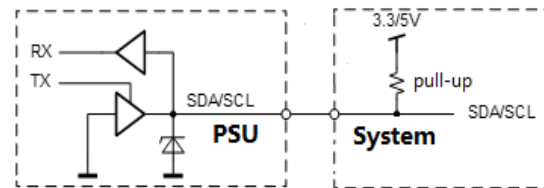

Figure 16. Physical layer of communication interface

The SMB\_ALERT\_L signal indicates that the power supply is experiencing a problem that the system agent should investigate. This is a logical OR of the Shutdown and Warning events. The power supply responds to a read command on the general SMB\_ALERT\_L call address 25(0x19) by sending its status register.

Communication to the DSP or the EEPROM will be possible as long as the input AC voltage is provided. If no AC is present, communication to the unit is possible as long as it is connected to a life V1 output (provided e.g. by the redundant unit). If only VSB is provided, communication is not possible.

PARAMETER	DESCRIPTION / CONDITION	MIN	NOM	MAX	UNIT
$V_{IL}$	Input low voltage	-0.5		1.0	V
$V_{IH}$	Input high voltage	2.3		5.5	V
$V_{hys}$	Input hysteresis	0.15			V
$V_{oL}$	Output low voltage	0		0.4	V
$t_r$	Rise time for SDA and SCL ( $V_{iLmax}-0.15V$ to $V_{iHmin}+0.15V$ )	0.65V to 2.25V $f_{SCL} \leq 100$ kHz		1000	ns
$t_{of}$	Output fall time ( $V_{iHmin}+0.15V$ to $V_{iLmax}-0.15V$ )	2.25V to 0.65V $f_{SCL} \leq 100$ kHz		300	ns
$I_i$	Input current SCL/SDA	0.1 VDD < $V_i$ < 0.9 VDD		10	$\mu A$
$C_i$	Internal Capacitance for each SCL/SDA			50	pF
$f_{SCL}$	SCL clock frequency	0		100	kHz
$R_{pu}$	External pull-up resistor	$f_{SCL} \leq 100$ kHz		1000 ns / Cb <sup>3</sup>	$\Omega$
$t_{HDSTA}$	Hold time (repeated) START	$f_{SCL} \leq 100$ kHz		4.0	$\mu s$
$t_{LOW}$	Low period of the SCL clock	$f_{SCL} \leq 100$ kHz		4.7	$\mu s$

<sup>3</sup> Cb = Capacitance of bus line in pF, typically in the range of 10...400 pF



$t_{HIGH}$	High period of the SCL clock	$f_{SCL} \leq 100 \text{ kHz}$	4.0	$\mu\text{s}$
$t_{SUSTA}$	Setup time for a repeated START	$f_{SCL} \leq 100 \text{ kHz}$	4.7	$\mu\text{s}$
$t_{HDDAT}$	Data hold time	$f_{SCL} \leq 100 \text{ kHz}$	0	3.45 $\mu\text{s}$
$t_{SUDAT}$	Data setup time	$f_{SCL} \leq 100 \text{ kHz}$	250	ns
$t_{SUSTO}$	Setup time for STOP condition	$f_{SCL} \leq 100 \text{ kHz}$	4.0	$\mu\text{s}$
$t_{BUF}$	Bus free time between STOP and START	$f_{SCL} \leq 100 \text{ kHz}$	5	ms

Table 8. I2C / SMBus Specification

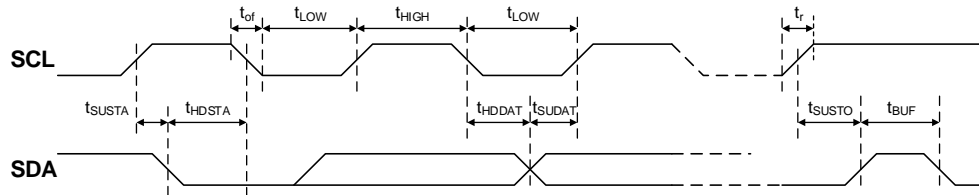

Figure 17. I2C / SMBus Timing

### 8.14 ADDRESS / PROTOCOL SELECTION (APS)

The APS pin provides the possibility to select the address by connecting a resistor to V1 return (0 V). A fixed addressing offset exists between the Controller and the EEPROM.

**NOTES:**

- If the APS pin is left open, the supply will operate with the Power Management Bus protocol at controller / EEPROM addresses 0xB6 / 0xA6.
- The APS pin is only read at start-up of the power supply. Therefore, it is not possible to change address dynamically.

$R_{APS} (\Omega)$ <sup>4</sup>	Protocol	I2C Address <sup>5</sup>	
		Controller	EEPROM
820	Power Management Bus	0xB0	0xA0
2700		0xB2	0xA2
5600		0xB4	0xA4
8200		0xB6	0xA6
15000	PSMI	0xB0	0xA0
27000		0xB2	0xA2
56000		0xB4	0xA4
180000		0xB6	0xA6

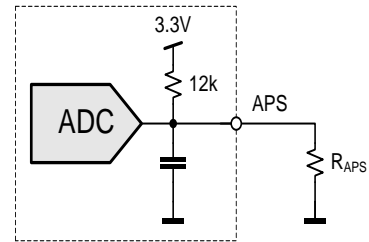

Figure 18. I2C address and protocol setting

### 8.15 CONTROLLER AND EEPROM ACCESS

The controller and the EEPROM in the power supply share the same I2C bus physical layer, see Figure 16. An I2C driver device assures logic level shifting (3.3/5 V) and a glitch-free clock stretching. The driver also pulls the SDA/SCL line to nearly 0 V when driven low by the DSP or the EEPROM providing maximum flexibility when additional external bus repeaters are needed. Such repeaters usually encode the low state with different voltage levels depending on the transmission direction.

The DSP will automatically set the I2C address of the EEPROM with the necessary offset when its own address is changed / set. In order to write to the EEPROM, first the write protection needs to be disabled by sending the appropriate command to the DSP. By default, the write protection is on.

The EEPROM provides 256 bytes of user memory. None of the bytes are used for the operation of the power supply.

<sup>4</sup> E12 resistor values, use max 5% resistors  
<sup>5</sup> The LSB of the address byte is the R/W bit



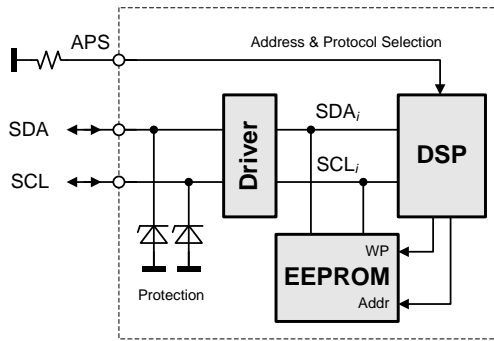

Figure 19. I2C Bus to DPS and EEPROM

### 8.16 EEPROM PROTOCOL

The EEPROM follows the industry communication protocols used for this type of device. Even though page write / read commands are defined, it is recommended to use the single byte write / read commands.

#### WRITE

The write command follows the SMBus 1.1 Write Byte protocol. After the device address with the write bit cleared a first byte with the data address to write to is sent followed by the data byte and the STOP condition. A new START condition on the bus should only occur after 5ms of the last STOP condition to allow the EEPROM to write the data into its memory.

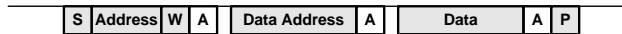

#### READ

The read command follows the SMBus 1.1 Read Byte protocol. After the device address with the write bit cleared the data address byte is sent followed by a repeated start, the device address and the read bit set. The EEPROM will respond with the data byte at the specified location.

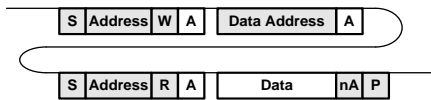

### 8.17 POWER MANAGEMENT BUS PROTOCOL

The Power Management Bus is an open standard protocol that defines means of communicating with power conversion and other devices. For more information, please see the System Management Interface Forum web site at [www.powerSIG.org](http://www.powerSIG.org).

Power Management Bus command codes are not register addresses. They describe a specific command to be executed. The PFS1200-12-054NAH supply supports the following basic command structures:

- Clock stretching limited to 1 ms
- SCL low time-out of >25 ms with recovery within 10 ms
- Recognized any time Start/Stop bus conditions

#### WRITE

The write protocol is the SMBus 1.1 Write Byte/Word protocol. Note that the write protocol may end after the command byte or after the first data byte (Byte command) or then after sending 2 data bytes (Word command).

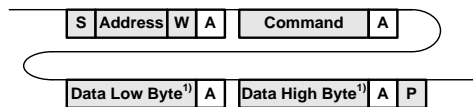

¹) Optional

In addition, Block write commands are supported with a total maximum length of 255 bytes. See PFS Programming Manual for further information.

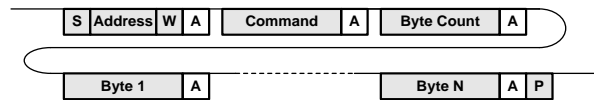

**READ**

The read protocol is the SMBus 1.1 Read Byte/Word protocol. Note that the read protocol may request a single byte or word.

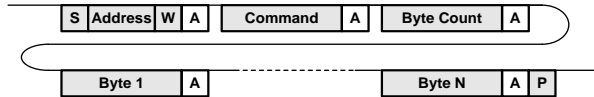

In addition, Block read commands are supported with a total maximum length of 255 bytes. See PFS Programming Manual BCA.00006 for further information.

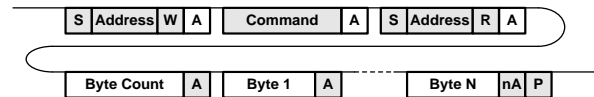

**8.18 PSMI PROTOCOL**

New power management features in computer systems require the system to communicate with the power supply to access current, voltage, fan speed, and temperature information. Current measurements provide data to the system for determining potential system configuration limitations and provide actual system power consumption for facility planning. Temperature and fan monitoring allow the system to better manage fan speeds and temperatures for optimizing system acoustics. Voltage monitoring allows the system to calculate input wattage and warning of system voltage regulation problems. The Power Supply Management Interface (PSMI) supports diagnostic capabilities and allows managing of redundant power supplies. The communication method is SMBus. The current design guideline is version 2.12.

The communication protocol is register based and defines a read and write communication protocol to read / write to a single register address. All registers are accessed via the same basic command given below. No PEC (Packet Error Code) is used.

**WRITE**

The write protocol used is the SMBus 2.0 Write Word protocol. All writes are 16-bit words; byte reads are not supported nor allowed. The shaded areas in the figure indicate bits and bytes written by the PSMI master device. See PFS Programming Manual for further information.

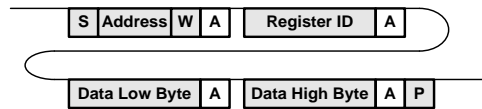

**READ**

The read protocol used is the SMBus 2.0 Read Word protocol. All reads are 16-bit words; byte reads are not supported nor allowed. The shaded areas in the figure indicate bits and bytes written by the PSMI master device. See PFS Programming Manual for further information.

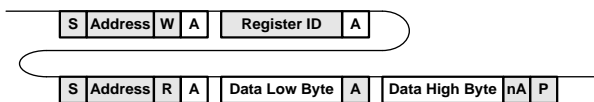

**8.19 GRAPHICAL USER INTERFACE**

Bel Power Solutions provides with its “Bel Power Solutions I2C Utility” a Windows® XP/Vista/Win7 compatible graphical user interface allowing the programming and monitoring of the PFS1200 Front-End. The utility can be downloaded on: [belfuse.com/power-solutions](http://belfuse.com/power-solutions) and supports Power Management Bus protocols.

The GUI allows automatic discovery of the units connected to the communication bus and will show them in the navigation tree. In the monitoring view the power supply can be controlled and monitored.

If the GUI is used in conjunction with the SNP-OP-BOARD-01 or YTM.G1Q01.0 Evaluation Kit it is also possible to control the PSON\_L pin(s) of the power supply.



Further there is a button to disable the internal fan for approximately 10 seconds. This allows the user to take input power measurements without fan consumptions to check efficiency compliance to the Climate Saver Computing Platinum specification.

The monitoring screen also allows to enable the hot-standby mode on the power supply. The mode status is monitored and by changing the load current it can be monitored when the power supply is being disabled for further energy savings. This obviously requires 2 power supplies being operated as a redundant system (as in the evaluation kit).

**NOTE:** The user of the GUI needs to ensure that only one of the power supplies have the hot-standby mode enabled.

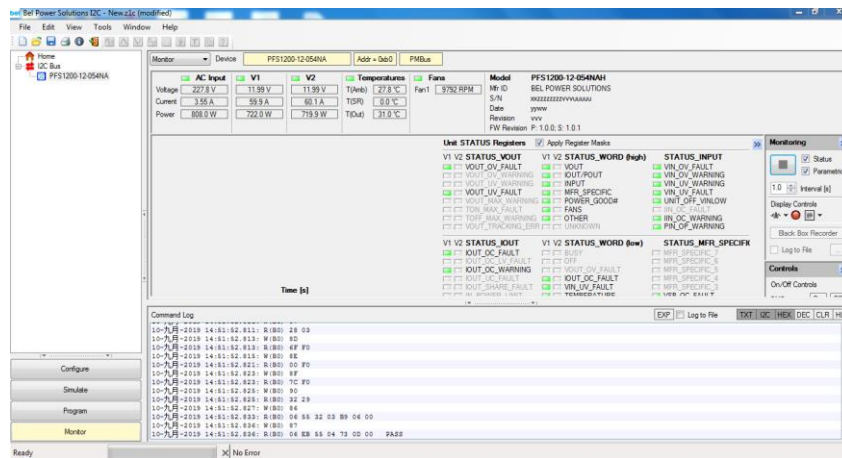

Figure 20. Monitoring dialog of the I2C Utility

## 9. TEMPERATURE AND FAN CONTROL

To achieve best cooling results sufficient airflow through the supply must be ensured. Do not block or obstruct the airflow at the rear of the supply by placing large objects directly at the output connector. The PFS1200-12-054NA series PSU is provided with normal airflow, which means the air enters through the DC output connector side of the supply and leaves at the AC input socket side. PFS supplies have been designed for horizontal operation.

The fan inside of the supply is controlled by a microprocessor. The RPM of the fan is adjusted to ensure optimal supply cooling and is a function of output power and the inlet temperature.

For the normal airflow version additional constraints apply because of the AC-connector. In a normal airflow unit, the hot air is exiting the power supply unit at the AC-inlet.

The IEC connector on the unit is rated 105°C. If 70°C mating connector is used then end user must derated the input power to meet a maximum 70°C temperature at the front.

**NOTE:** It is the responsibility of the user to check the front temperature in such cases. The unit is not limiting its power automatically to meet such a temperature limitation.

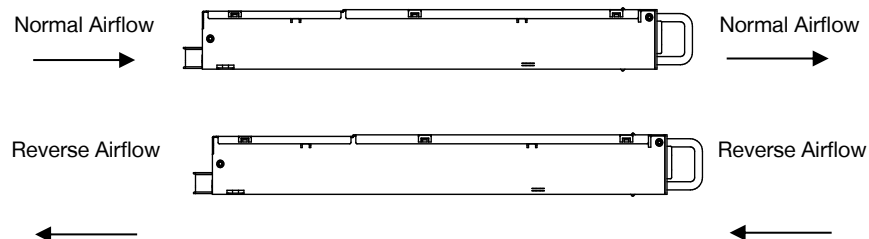

Figure 21. Airflow direction

## 10. ELECTROMAGNETIC COMPATIBILITY

### 10.1 IMMUNITY

**NOTE:** Most of the immunity requirements are derived from EN 55024:1998/A2:2003.

PARAMETER	DESCRIPTION / CONDITION	CRITERION
ESD Contact Discharge	IEC / EN 61000-4-2, ±8 kV, 25+25 discharges per test point (metallic case, LEDs, connector body)	A
ESD Air Discharge	IEC / EN 61000-4-2, ±15 kV, 25+25 discharges per test point (non-metallic user accessible surfaces)	A
Radiated Electromagnetic Field	IEC / EN 61000-4-3, 10 V/m, 1 kHz/80% Amplitude Modulation, 1 µs Pulse Modulation, 10 kHz...2 GHz	A
Burst	IEC / EN 61000-4-4, level 3 AC port ±2 kV, 1 minute DC port ±1 kV, 1 minute	A
Surge	IEC / EN 61000-4-5 Line to earth: level 3, ±2 kV Line to line: level 2, ±1 kV	A
RF Conducted Immunity	IEC/EN 61000-4-6, Level 3, 10 Vrms, CW, 0.15 ... 80 MHz	A
Voltage Dips and Interruptions	IEC/EN 61000-4-11 1: Vi 230 V, 100% Load, Phase 0 °, Dip 100%, Duration 10 ms 2: Vi 230 V, 100% Load, Phase 0 °, Dip 100%, Duration 20 ms 3: Vi 230 V, 100% Load, Phase 0 °, Dip 100%, Duration >20 ms	A Vsb: A, Vi: B B

### 10.2 EMISSION

PARAMETER	DESCRIPTION / CONDITION	CRITERION
Conducted Emission	EN 55032 / CISPR 32: 0.15 ... 30 MHz, QP and AVG, single unit	Class A
	EN 55032 / CISPR 32: 0.15 ... 30 MHz, QP and AVG, 2 units in rack system	Class A
Radiated Emission	EN 55032 / CISPR 32: 30 MHz ... 1 GHz, QP, single unit	Class A
	EN 55032 / CISPR 32: 30 MHz ... 1 GHz, QP, 2 units in rack system	Class A
Harmonic Emissions	IEC 61000-3-2, Vin = 115 VAC / 60 Hz, & Vin = 230 VAC / 50 Hz, 100% Load	Class A
AC Flicker	IEC 61000-3-3, Vin = 230 VAC / 60 Hz, 100% Load	Pass

## 11. SAFETY APPROVALS

Maximum electric strength testing is performed in the factory according to IEC/EN 62368-1, and UL/CSA 62368-1. Input-to-output electric strength tests should not be repeated in the field. Bel Power Solutions will not honor any warranty claims resulting from electric strength field tests.

PARAMETER	DESCRIPTION / CONDITION	MIN	NOM	MAX	UNIT
Agency Approvals	UL 62368-1 CAN/CSA-C22.2 No. 62368-1 IEC 62368-1 EN 62368-1		Approved		
Isolation Strength	Input (L/N) to case (PE)		Basic		
	Input (L/N) to output		Reinforced		
	Output to case (PE)		Functional		
α Creepage / Clearance	Primary (L/N) to protective earth (PE) Primary to secondary		According to safety standard		mm
Electrical Strength Test	Input to case		2.5		
	Input to output		4.0(Vin≤250VAC) 5.0(250VAC<Vin≤300VAC)		kVDC



Asia-Pacific  
+86 755 298 85888

Europe, Middle East  
+353 61 49 8941

North America  
+1 866 513 2839

Output and Signals to case

## 12. ENVIRONMENTAL SPECIFICATIONS

PARAMETER	DESCRIPTION / CONDITION	MIN	NOM	MAX	UNIT
$T_A$	Ambient Temperature	$V_{I \min}$ to $V_{I \max}$ , $I_{nom}$ , $I_{SB \text{ nom}}$ below 1800 m Altitude ( $< 1800$ m, keep maximum operation temperature. $\geq 1800$ m, decrease $1^\circ \text{C}$ per 300 m)			$^\circ\text{C}$
$T_{A \text{ ext}}$	Extended Temp. Range	Derating output			$^\circ\text{C}$
$T_S$	Storage Temperature	Non-operational			$^\circ\text{C}$
	Altitude	Operational, above Sea Level, refer derating to $T_A$			m
$N_A$	Audible Noise	$V_{I \text{ nom}}$ , 50% $I_{\text{nom}}$ , $T_A = 25^\circ\text{C}$			dBA

## 13. MECHANICAL SPECIFICATIONS

PARAMETER	DESCRIPTION / CONDITION	MIN	NOM	MAX	UNIT
Dimensions	Width		54.5		
	Height		40.0		mm
	Depth		228.6		
$M$	Weight		0.87		kg

## PFS1200-12-054NAH, PFS1200-12-054RAH

**Input AC connector Anderson Power Products 2006G1-BK**

**NOTE:** A 3D step file of the power supply casing is available on request.

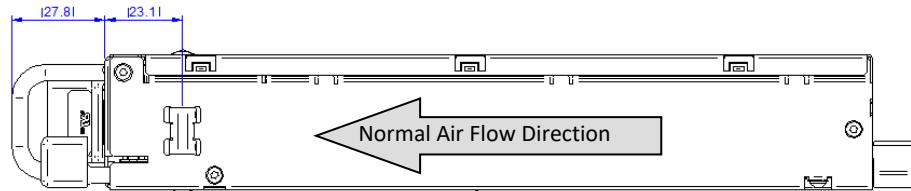

Figure 22. Side View

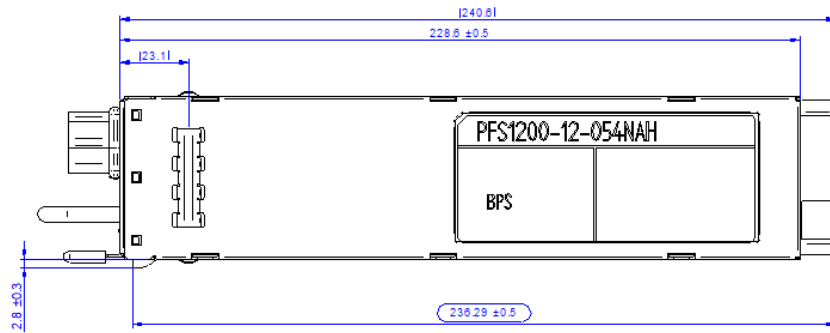

Figure 23. Top View

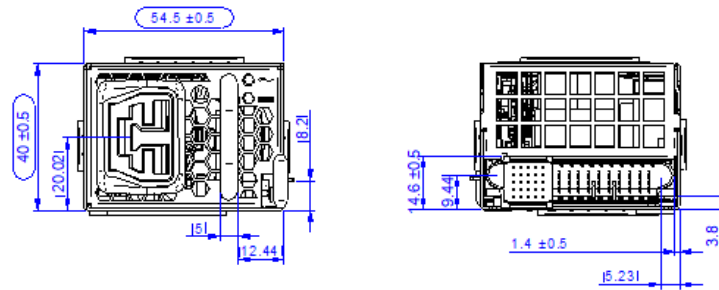

Figure 24. Front and Rear View



**PFS1200-12-054NA, PFS1200-12-054RA**

**C14 Type Input AC connector Rong Feng SS-120-1.0B-2.8BV or equivalent**

**NOTE: A 3D step file of the power supply casing is available on request.**

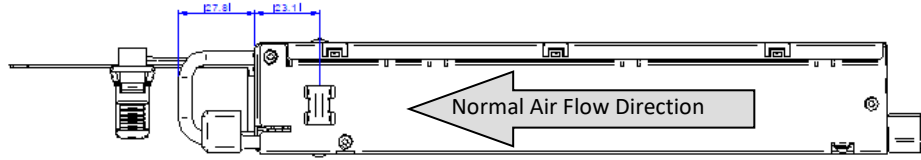

Figure 25. Side View

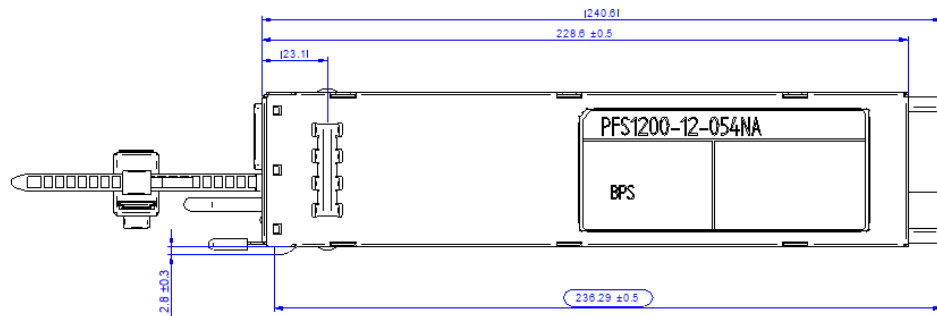

Figure 26. Side View

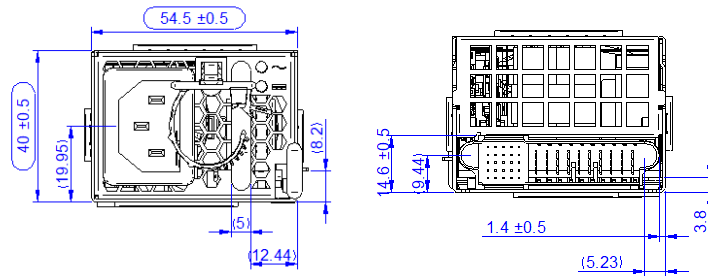

Figure 27. Side View



**PFS1200-12-054NAC, PFS1200-12-054RAC**

**C16 Type Input AC connector Rong Feng SS-120B-1.0-4.0Ad or equivalent**

**NOTE: A 3D step file of the power supply casing is available on request.**

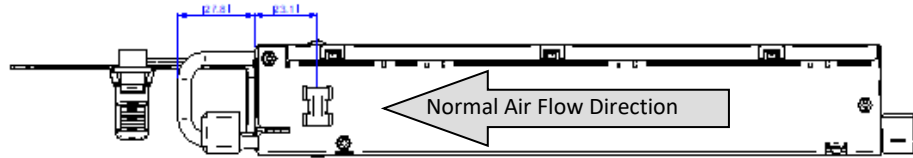

Figure 28. Side View

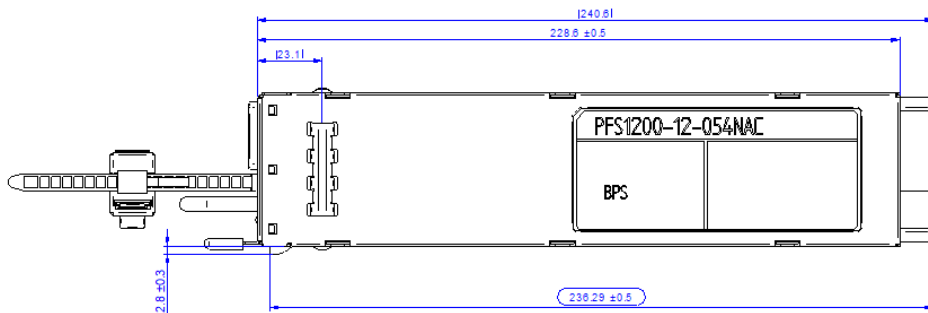

Figure 29. Side View

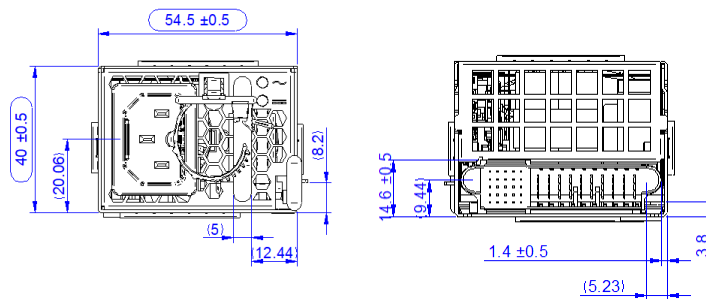

Figure 30. Side View



## 14. CONNECTIONS

### 14.1 AC INPUT CONNECTOR:

PFS1200-12-054NAH: **Power supplier connector:** ANDERSON POWER PRODUCTS 2006G1-BK  
**Mating connector:** Anderson Saf-D-Grid Power cord 2034KZ2 or equivalent,  
<http://www.andersonpower.com/>  
PFS1200-12-054NA/RA: Power supplier connector: IEC320 C14 type  
PFS1200-12-054NAC/RAC: Power supplier connector: IEC320 C16 type

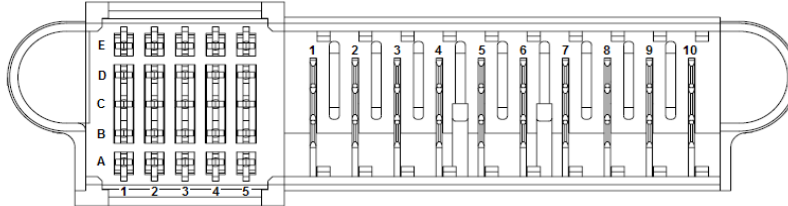

### 14.2 DC OUTPUT CONNECTOR:



Power Supply Connector: Tyco Electronics P/N 1926736-3 or FCI 101-10133129-002LF or equivalent (NOTE: Column 5 is recessed (short pins))  
Mating Connector: Tyco Electronics P/N 2-1926739-5 or FCI 10108888-R10253SLF

PIN	NAME	DESCRIPTION
<b>Output</b>		
6, 7, 8, 9, 10	V1	+12 VDC main output
1, 2, 3, 4, 5	PGND	Power ground (return)
<b>Control Pins</b>		
A1	VSB	Standby positive output
B1	VSB	Standby positive output
C1	VSB	Standby positive output
D1	VSB	Standby positive output
E1	VSB	Standby positive output
A2	SGND	Signal ground (VSB Return)
B2	SGND	Signal ground (VSB Return)
C2	HOTSTANDBYEN_H	Hot standby enable signal: active-high
D2	VSB_SENSE_R	VSB output negative sense
E2	VSB_SENSE	VSB output positive sense
A3	APS	I <sup>2</sup> C address and protocol selection (select by a pull down resistor)
B3	N/C	Reserved
C3	SDA	I <sup>2</sup> C data signal line
D3	V1_SENSE_R	Main output negative sense
E3	V1_SENSE	Main output positive sense
A4	SCL	I <sup>2</sup> C clock signal line
B4	PSON_L	Power supply on input (connect to A2/B2 to turn unit on): active-low
C4	SMB_ALERT_L	SMB Alert signal output: active-low
D4	VSB_SEL1	VSB voltage selection (See section 8.9)
E4	ACOK_H	AC input OK signal: active-high
A5	PSKILL_H	Power supply kill (lagging pin): active-high
B5	ISHARE	Current share bus (lagging pin)
C5	PWOK_H	Power OK signal output (lagging pin): active-high
D5	VSB_SEL2	VSB voltage selection (See section 8.9)
E5	PRESENT_L	Power supply present (lagging pin): active-low

15. ACCESSORIES

ITEM	DESCRIPTION	ORDERING PART NUMBER	SOURCE
	<p>Bel Power Solutions I<sup>2</sup>C Utility</p> <p>Windows XP/Vista/7 compatible GUI to program, control and monitor PFS Front-Ends (and other I<sup>2</sup>C units)</p>	<p>N/A</p>	<p><a href="http://belfuse.com/power-solutions">belfuse.com/power-solutions</a></p>
	<p>Dual Connector Board</p> <p>Connector board to operate 2 PFS units in parallel. Includes an on-board USB to I<sup>2</sup>C converter (use <i>Bel Power Solutions I<sup>2</sup>C Utility</i> as desktop software).</p>	<p>YTM.G2Q01.0</p>	<p><a href="http://belfuse.com/power-solutions">belfuse.com/power-solutions</a></p>



**Asia-Pacific**  
+86 755 298 85888

**Europe, Middle East**  
+353 61 49 8941

**North America**  
+1 866 513 2839

## 16. REVISION HISTORY

DATE	REVISION	CHANGE	PREPARED BY	APPROVED BY	ECO NO.
2019/10/21	1	Initial release	Mike Chen	Mike Chen	C92902
2019/10/21	2	General update throughout the whole datasheet	Steven Ling	Mike Chen	C96518
2019/11/28	3	AC input change to max 305V	Steven Ling	Mike Chen	
2019/10/21	3	Update output derating curve	Steven Ling	BJ Zeng	
2020/10/26	3	Add project PFS1200-12-054NA/RA/NAC/RAC and the mechanical drawing	Chad Cai	BJ Zeng	
2020/11/27	3	Update Figure 6b Ambient derating curve	Steven Ling	BJ Zeng	
2021/03/16	A	Upgrade to revision A	Steven Ling	BJ Zeng	CO111131
2021/04/15	B	Current Sharing from $\pm 5\%$ to $\pm 3A$	Steven Ling	BJ Zeng	CO112402
2021/09/16	C	Change VSB VOLTAGE SELECTION Logic	Steven Ling	BJ Zeng	CO115336
2023/04/14	D	Update front LEDs status Change format of some text	Xiaogang Luo	Gang Wang	CO127295
2023/07/20	E	Simplify the LED status condition description in Table 3.	Eisen Xu	Jemrry Zhang	CO129050
2023/08/09	F	Update picture of Figure 22&30 and picture at page 1, Update output connector MPN at section 14 Update the mechanical picture at section 13 Update the safety approve standard and electrical strength test at section 11	Chad Cai	Andrew Li	
2024/03/04	G	Update the drawing on p. 1 with real product image	VS		CO132579

For more information on these products consult: [tech.support@psbel.com](mailto:tech.support@psbel.com)

**NUCLEAR AND MEDICAL APPLICATIONS** - Products are not designed or intended for use as critical components in life support systems, equipment used in hazardous environments, or nuclear control systems.

**TECHNICAL REVISIONS** - The appearance of products, including safety agency certifications pictured on labels, may change depending on the date manufactured. Specifications are subject to change without notice.

