

NON-ISOLATED DC/DC CONVERTERS

8.3 Vdc - 14 Vdc Input

0.75 Vdc - 5.5 Vdc/6 A Output



Jan. 25, 2013

Bel Power, Inc. , a subsidiary of Bel Fuse, Inc.

SRBA-06A2Ax

RoHS Compliant

Rev.D

- Non-Isolated
- High Efficiency
- High Power Density
- Fixed Frequency
- Remote On/Off
- Active Low/High
- Certificated to UL60950-1/CSA C22.2 No.60950-1, 2nd edition, am1
- Class 2, Category 2, Non-Isolated DC/DC Converter (refer to IPC-9592A)
- Under-Voltage Lockout (UVLO)
- OCP/SCP
- Wide Input
- Wide Trim Range
- Flexible Output Voltage Sequencing



Applications

- Networking
- Computers and peripherals
- Telecommunications

Description

The Bel SRBA-06A2Ax modules are a series of non-isolated dc/dc converters that deliver up to 6 A of output current with full load efficiency of 92% at 5.0 Vdc output. These modules provide precisely regulated voltage programmable via external resistor from 0.75 Vdc to 5.5 Vdc over a wide range of input voltage (8.3 Vdc - 14 Vdc). These modules have a sequencing feature that enables designers to implement various types of output voltage sequencing when powering multiple voltages on a board. The open-frame construction and small footprint enable designers to develop cost and space-efficient solutions. Standard features include remote On/Off, over current protection, short current protection, wide input, and programmable output voltage.

Part Selection

| Output Voltage | Input Voltage | Max. Output Current | Max. Output Power | Typical Efficiency | Model Number Active Low | Model Number Active High |
|----------------|---------------|---------------------|-------------------|--------------------|-------------------------|--------------------------|
| 0.75 V - 5.5 V | 8.3 V - 14 V | 6 A | 33 W | 92% | SRBA-06A2AL | SRBA-06A2A0 |

- Notes:** 1. Add "G" suffix at the end of the model numbers listed above to indicate "Tray Packaging"
2. Add "H" suffix at the end of the model number to indicate Tray packaging and RoHS compliant without requiring exemption 7c-III.

Part Number Explanation

S R BA - 06 A 2A x
1 2 3 4 5 6 7

1---Surface mount

2---RoHS6, change "R" to "7" means RoHS5

3---Series name

4---Series code

5---Wide input range (8.3-14V)

6---Wide trim

7---Option, "x" of the model part number to be 0-9, A-Z, which will represent the special request of customer.

NON-ISOLATED DC/DC CONVERTERS

8.3 Vdc - 14 Vdc Input

0.75 Vdc - 5.5 Vdc/6 A Output



Jan. 25, 2013

Bel Power, Inc., a subsidiary of Bel Fuse, Inc.

Absolute Maximum Ratings

| Parameter | Min | Typ | Max | Notes |
|---------------------------------|--------|-----|-----------------|-------|
| Input Voltage (continuous) | -0.3 V | - | 15 V | |
| Output Enable Terminal Voltage | -0.3 V | - | 15 V | |
| Sequencing Voltage ¹ | -0.3 V | - | V _{in} | |
| Ambient Temperature | -40 °C | - | 85 °C | |
| Storage Temperature | -55 °C | - | 125 °C | |

Notes: All specifications are typical at 25 °C unless otherwise stated.

1. SRBA-06A2Ax series of modules include a sequencing feature that enables users to implement various types of output voltage sequencing in their applications. This is accomplished via an additional sequencing pin. When the sequencing feature is not used, tie the SEQ pin to V_{in} or leave the SEQ pin floating.

Input Specifications

| Parameter | Min | Typ | Max | Notes |
|---|-------|------------------------|-----------------------|--|
| Input Voltage | 8.3 V | 12 V | 14 V | |
| Input Current (full load) | | | | |
| V _o =5.0 V | - | 2.75 A | 4.0 A | |
| V _o =3.3 V | - | 1.85 A | 2.8 A | |
| V _o =2.5 V | - | 1.45 A | 2.2 A | |
| V _o =1.8 V | - | 1.05 A | 1.6 A | |
| V _o =1.2 V | - | 0.75 A | 1.1 A | |
| V _o =0.75 V | - | 0.55 A | 0.8 A | |
| Input Current (no load) | | | | |
| V _o =5.0 V | - | - | 100 mA | |
| V _o =0.75 V | - | - | 20 mA | |
| Remote Off Input Current | - | 1 mA | 2 mA | |
| Input Reflected Ripple Current (pk-pk) | - | 120 mA | - | Tested with two 100 uF/25 V tan input capacitors & simulated source impedance of 1 uH, 5 Hz to 20 MHz. |
| Input Reflected Ripple Current (rms) | - | 40 mA | - | |
| I ² t Inrush Current Transient | - | 0.002 A ² s | 0.02 A ² s | |
| Turn-on Voltage Threshold | - | 8.1 V | 8.2 V | |
| Turn-off Voltage Threshold | - | 7.5 V | 8.0 V | |

Notes: All specifications are typical at 25 °C unless otherwise stated.

Output Specifications

| Parameter | Min | Typ | Max | Notes |
|---|-------------------------|------------------------|------------------------|---|
| Output Voltage Set Point | -2%V _{o,set} | - | 2%V _{o,set} | V _{in} =12 V, full load |
| Output Voltage Set Point | -2.5%V _{o,set} | - | 3.5%V _{o,set} | Over all operating input voltages, resistive loads and temperature conditions |
| Adjustment Range Selected by External Resistor or Voltage | 0.7525 V | - | 5.5 V | |
| Load Regulation | - | 0.4%V _{o,set} | - | I _o =I _o , min to I _o , max |
| Line Regulation | - | 0.3%V _{o,set} | - | V _{in} =V _{in} , min to V _{in} , max |
| Regulation Over Temperature (-40 °C to +85 °C) | - | 0.5%V _{o,set} | - | T _{ref} =T _a , min to T _a , max |
| Output Current | 0 A | - | 6 A | |

NON-ISOLATED DC/DC CONVERTERS

8.3 Vdc - 14 Vdc Input

0.75 Vdc - 5.5 Vdc/6 A Output



Jan. 25, 2013

Bel Power, Inc., a subsidiary of Bel Fuse, Inc.

Output Specifications (continued)

| Parameter | Min | Typ | Max | Notes |
|---|----------------------|-----------------------|--------------------|--|
| Current Limit Threshold | 7.2 A | - | 18 A | |
| Short Circuit Surge Transient | - | 0.25 A ² s | - | |
| Ripple and Noise (pk-pk) Vo=0.75 V-3.63 V | - | 50 mV | 75 mV | Tested with 0-20 MHz, with 10 uF/10 V tantalum capacitor & 1 uF/10 V TDK ceramic capacitor at the output. |
| Ripple and Noise (rms) Vo=0.75 V-3.63 V | - | 15 mV | 30 mV | |
| Ripple and Noise (pk-pk) Vo=5.0 V | - | 75 mV | 100 mV | |
| Ripple and Noise (rms) Vo=5.0 V | - | 30 mV | 40 mV | |
| Turn on Time | - | 8 mS | 10 mS | |
| Overshoot at Turn on | - | 0% | 3% | |
| Output Capacitance ESR ≥ 1 mohm ESR ≥ 10 mohm | 0 uF 0 uF | - - | 1000 uF 3000 uF | |
| Transient Response | | | | |
| 50% ~ 100% Max Load | Vo = 0.75 - 5.5 V | - | 200 mV | di/dt=2.5 A/uS; Vin=12 V; and with 10 uF/10 V tantalum capacitor & 1 uF/10 V ceramic capacitor at the output. |
| Settling Time | | - | 50 uS | |
| 100% ~ 50% Max Load | | - | 200 mV | |
| Settling Time | | - | 50 uS | |

Note: All specifications are typical at nominal input (Vin=12 V), full load at 25 °C unless otherwise stated.

General Specifications

| Parameter | Min | Typ | Max | Notes |
|---|--|--|----------------------------|--|
| Efficiency Vo=5.0 V Vo=3.3 V Vo=2.5 V Vo=1.8 V Vo=1.2 V Vo=0.75 V | 90% 87% 85% 83% 79% 71% | 92% 89% 88% 86% 82% 74% | - - - - - - | Measured at Vin=12 V, full load |
| Switching Frequency | 250 kHz | 300 kHz | 350 kHz | |
| Over Temperature Shutdown | - | 135 °C | - | |
| Output Trim Range (wide trim) | 0.7525 V | - | 5.5 V | |
| MTBF | 3,079,469 hours | | | Calculated Per Bell Core SR-332 (Io = Nominal; Ta = 25 °C) |
| Dimensions Inches (L x W x H) Millimeters (L x W x H) | 0.8 x 0.45 x 0.251 20.32 x 11.42 x 6.38 | | | |
| Weight | - | 3 g | - | |

Note: All specifications are typical at 25 °C unless otherwise stated.

NON-ISOLATED DC/DC CONVERTERS

8.3 Vdc - 14 Vdc Input

0.75 Vdc - 5.5 Vdc/6 A Output



Jan. 25, 2013

Bel Power, Inc., a subsidiary of Bel Fuse, Inc.

Control Specifications

| Parameter | Min | Typ | Max | Notes |
|---------------------------------|------------|-----|-----------------|---|
| Signal Low (Unit Off) | -0.3 V | - | 0.4 V | SRBA-06A2A0; Remote On/Off pin open, Unit on. |
| Signal High (Unit On) | 2.5 V | - | 14 V | |
| Signal Low (Unit On) | -0.3 V | - | 0.4 V | SRBA-06A2AL; Remote On/Off pin open, Unit on. |
| Signal High (Unit Off) | 2.5 V | - | 14 V | |
| Sequencing Voltage | 0 V | - | V _{in} | Sequencing Voltage applied on SEQ pin should be higher than output voltage. |
| Sequencing Slew Rate Capability | - | - | 2 V/mS | |
| Sequencing Delay Time | 10 mS | - | - | Delay from V _{in} , min to application of voltage on SEQ pin |
| Tracking Accuracy | Power-Up | - | 100 mV | |
| | Power-Down | - | 200 mV | |

Output Trim Equations

Equation for calculating the trim resistor (in kΩ) given the desired adjusted voltage (V_{adj}) is shown below. The Trim Up resistor should be connected between the Trim pin and Ground.

$$R_{trim} = \frac{10.507}{V_{adj} - 0.7525} - 1$$

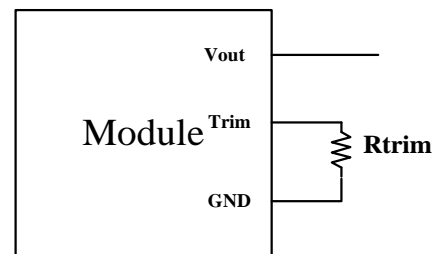

Equation for calculating the trim voltage (in V) given the desired adjusted voltage (V_{adj}) is shown below. The Trim Up voltage should be connected between the Trim pin and Ground.

$$V_{trim} = 0.7 - 0.0667 \times (V_{adj} - 0.7525)$$

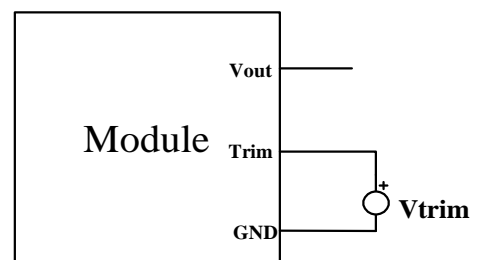

NON-ISOLATED DC/DC CONVERTERS

8.3 Vdc - 14 Vdc Input

0.75 Vdc - 5.5 Vdc/6 A Output



Jan. 25, 2013

Bel Power, Inc., a subsidiary of Bel Fuse, Inc.

Efficiency Data

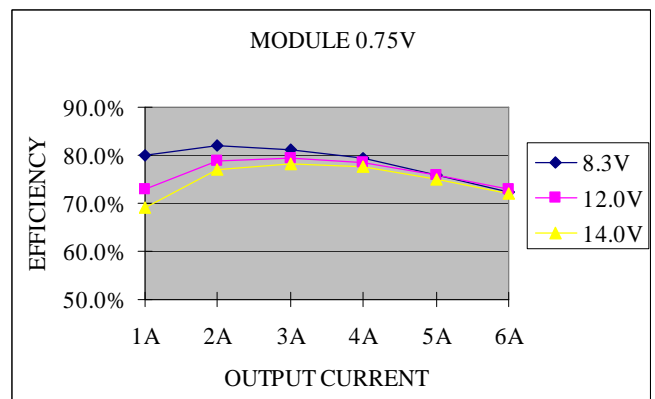
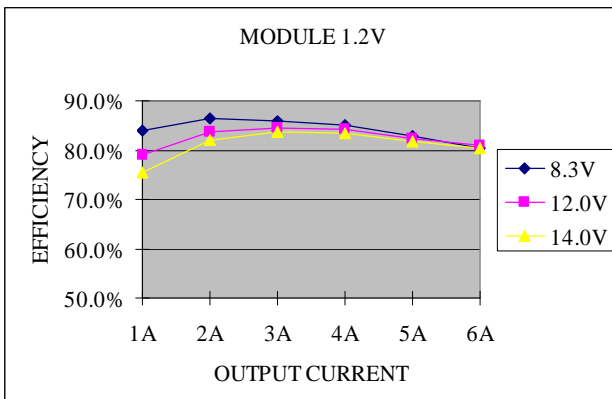
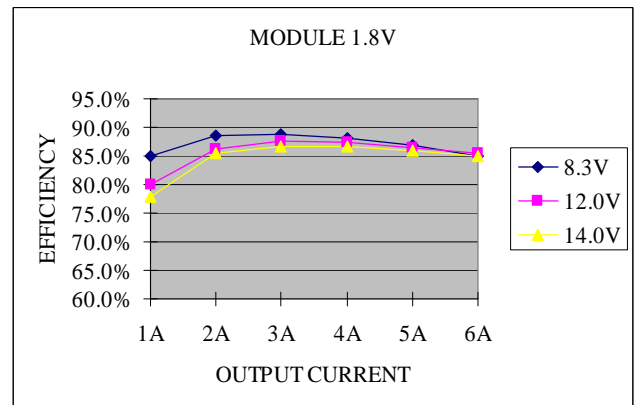
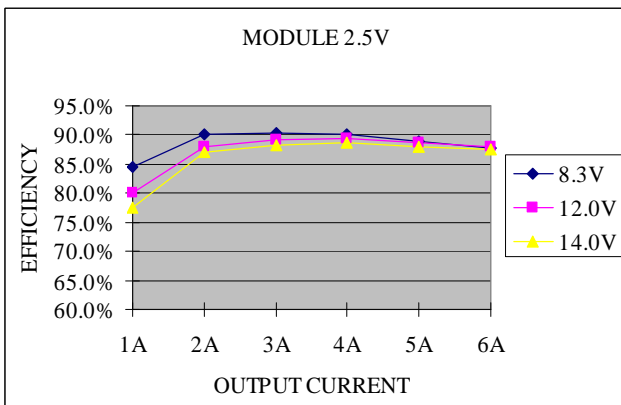
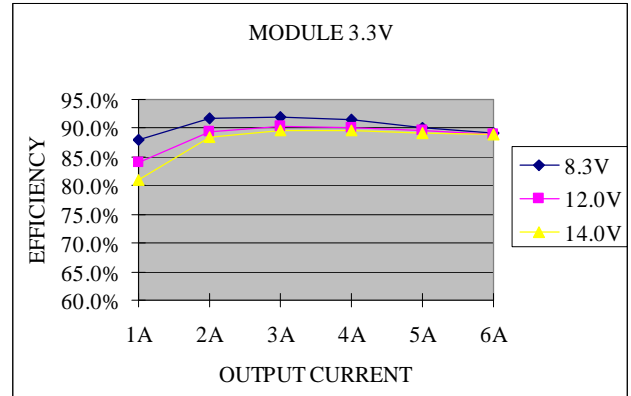
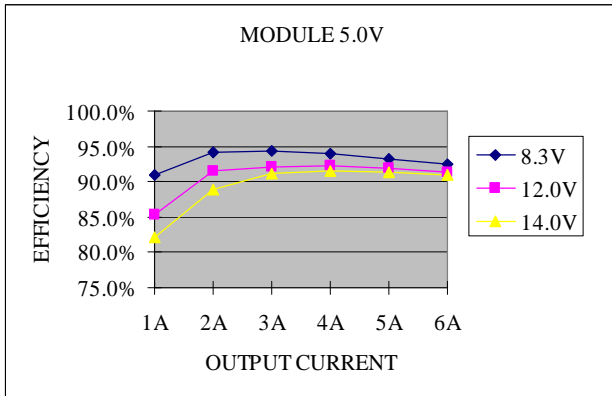

NON-ISOLATED DC/DC CONVERTERS

8.3 Vdc - 14 Vdc Input

0.75 Vdc - 5.5 Vdc/6 A Output



Jan. 25, 2013

Bel Power, Inc., a subsidiary of Bel Fuse, Inc.

Thermal Derating Curves

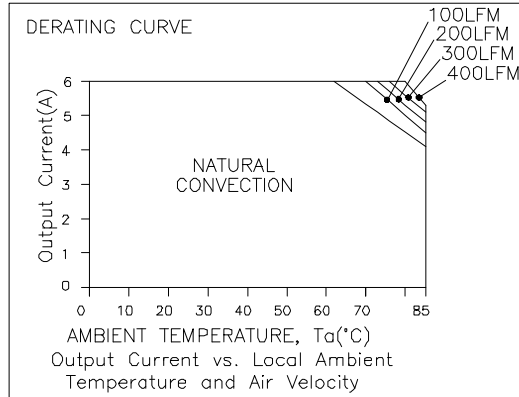

Vin=12 V, Vo=0.75 V

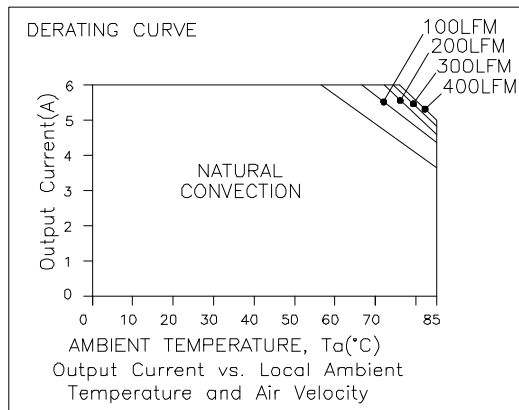

Vin=12 V, Vo=2.5 V

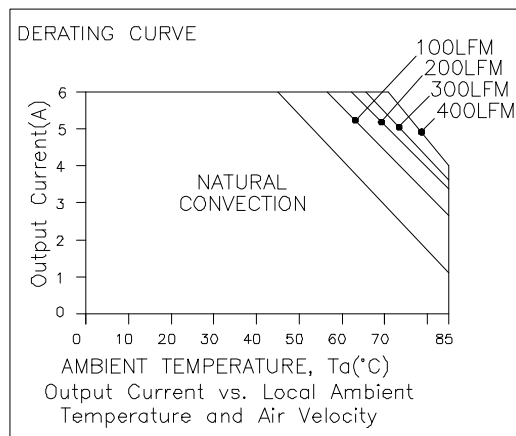

Vin=12 V, Vo=5.0 V

NON-ISOLATED DC/DC CONVERTERS

8.3 Vdc - 14 Vdc Input

0.75 Vdc - 5.5 Vdc/6 A Output



Jan. 25, 2013

Bel Power, Inc., a subsidiary of Bel Fuse, Inc.

Ripple and Noise Waveforms

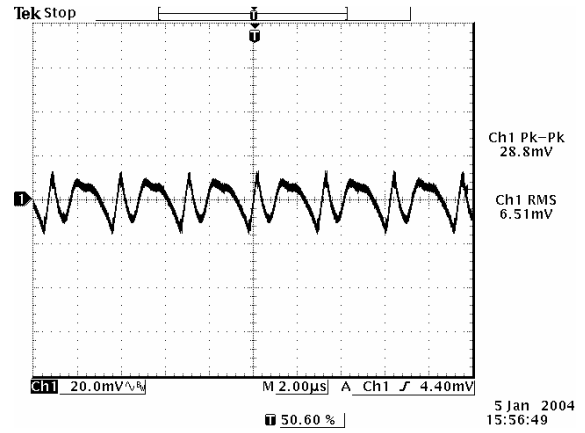
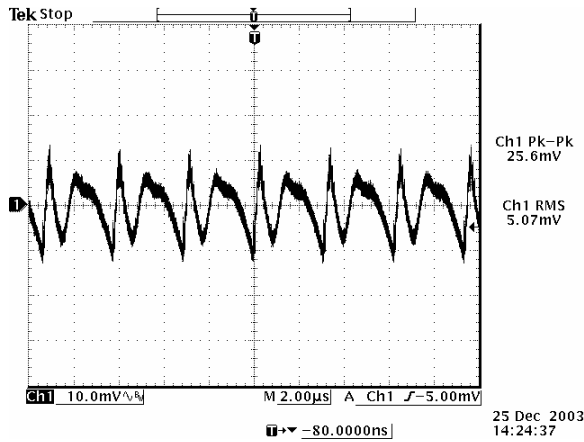

Ripple and noise at full load, $V_{in}=12$ V, $V_o=0.75$ V

Ripple and noise at full load, $V_{in}=12$ V, $V_o=1.2$ V

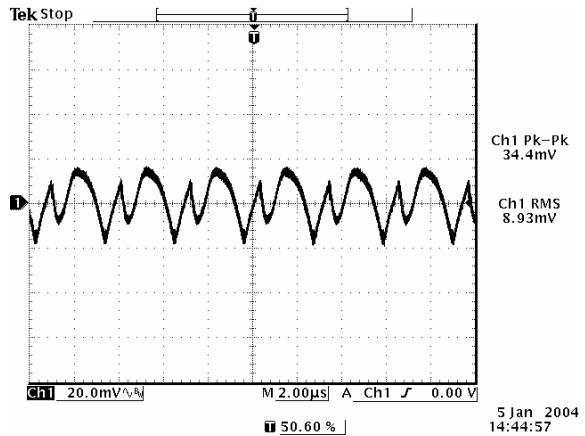
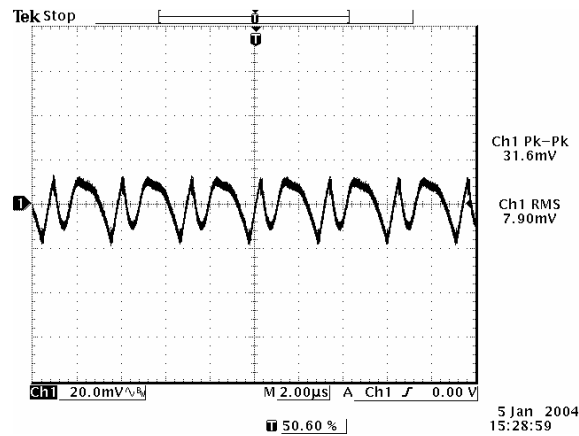

Ripple and noise at full load, $V_{in}=12$ V, $V_o=1.8$ V

Ripple and noise at full load, $V_{in}=12$ V, $V_o=2.5$ V

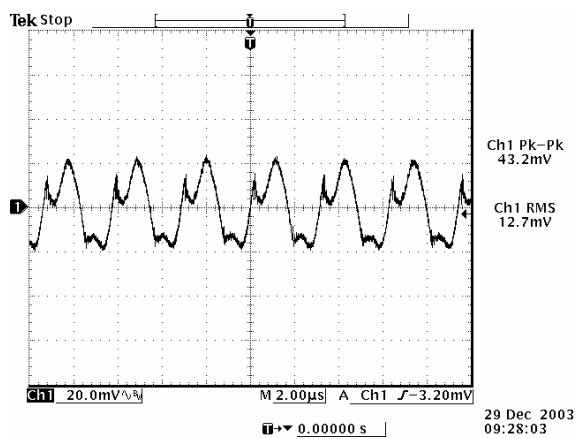
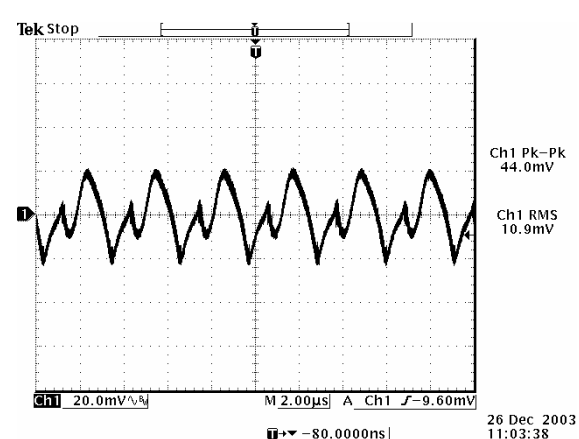

Ripple and noise at full load, $V_{in}=12$ V, $V_o=3.3$ V

Ripple and noise at full load, $V_{in}=12$ V, $V_o=5.0$ V

Note: The output ripple and noise is tested at 0-20 MHz BW, 10 μ F/10 V tantalum capacitor and 1 μ F/10 V ceramic capacitor, $T_a=25$ deg C.

NON-ISOLATED DC/DC CONVERTERS

8.3 Vdc - 14 Vdc Input

0.75 Vdc - 5.5 Vdc/6 A Output



Jan. 25, 2013

Bel Power, Inc., a subsidiary of Bel Fuse, Inc.

Transient Response Waveforms

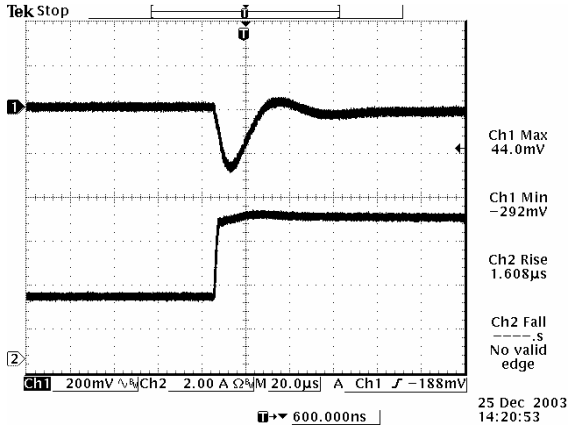

50% to 100% load step at $V_{in}=12\text{ V}$, $V_o=0.75\text{ V}$

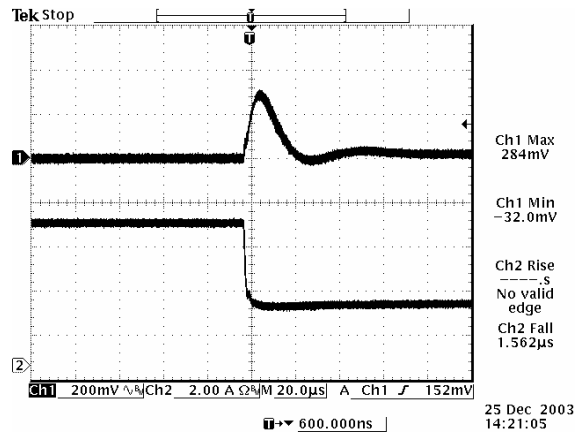

100% to 50% load step at $V_{in}=12\text{ V}$, $V_o=0.75\text{ V}$

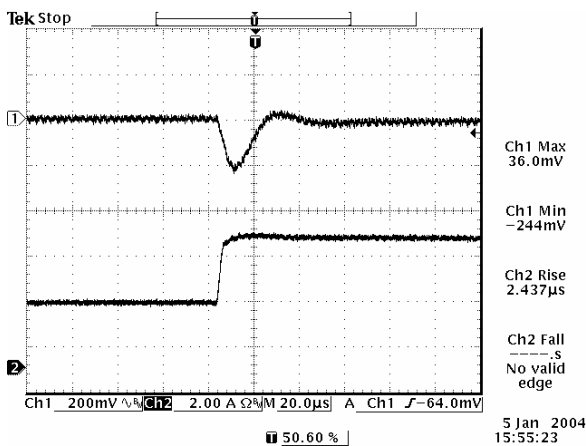

50% to 100% load step at $V_{in}=12\text{ V}$, $V_o=1.2\text{ V}$

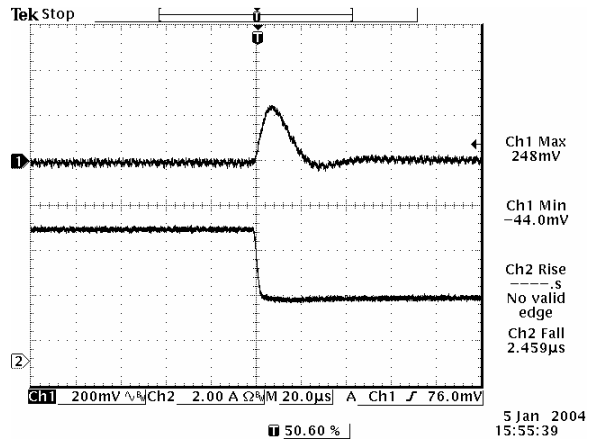

100% to 50% load step at $V_{in}=12\text{ V}$, $V_o=1.2\text{ V}$

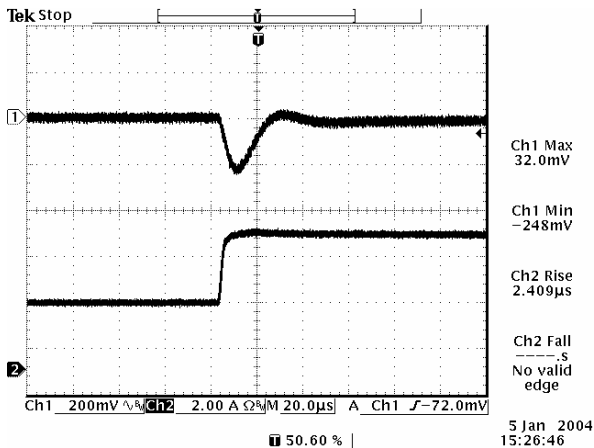

50% to 100% load step at $V_{in}=12\text{ V}$, $V_o=1.8\text{ V}$

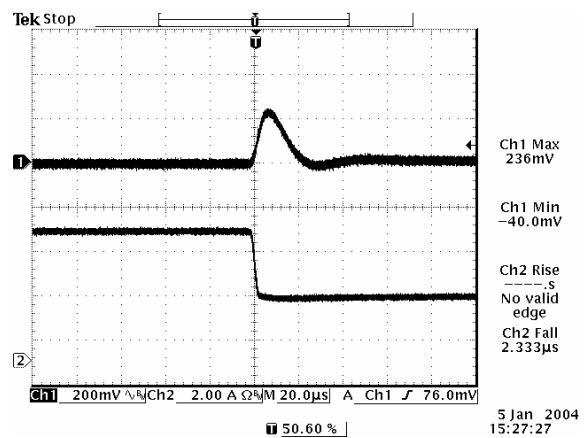

100% to 50% load step at $V_{in}=12\text{ V}$, $V_o=1.8\text{ V}$

NON-ISOLATED DC/DC CONVERTERS

8.3 Vdc - 14 Vdc Input

0.75 Vdc - 5.5 Vdc/6 A Output



Jan. 25, 2013

Bel Power, Inc., a subsidiary of Bel Fuse, Inc.

Transient Response Waveforms (continued)

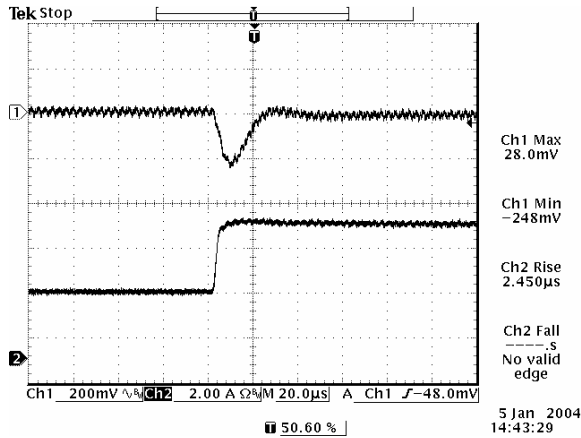

50% to 100% load step at $V_{in}=12\text{ V}$, $V_o=2.5\text{ V}$

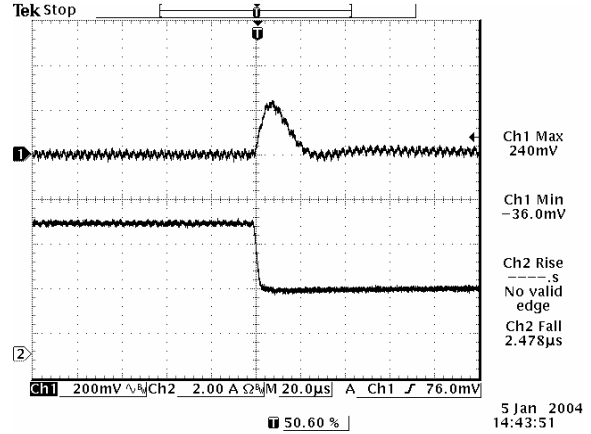

100% to 50% load step at $V_{in}=12\text{ V}$, $V_o=2.5\text{ V}$

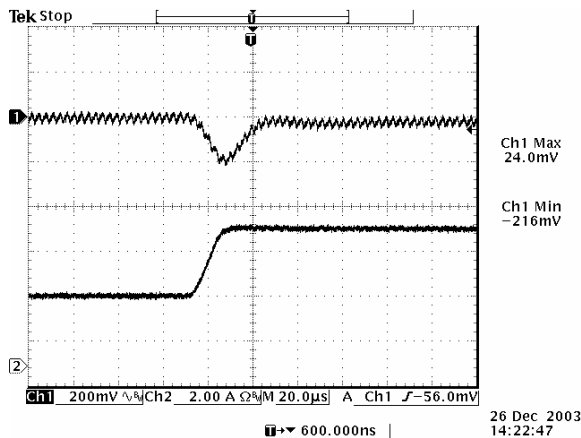

50% to 100% load step at $V_{in}=12\text{ V}$, $V_o=3.3\text{ V}$

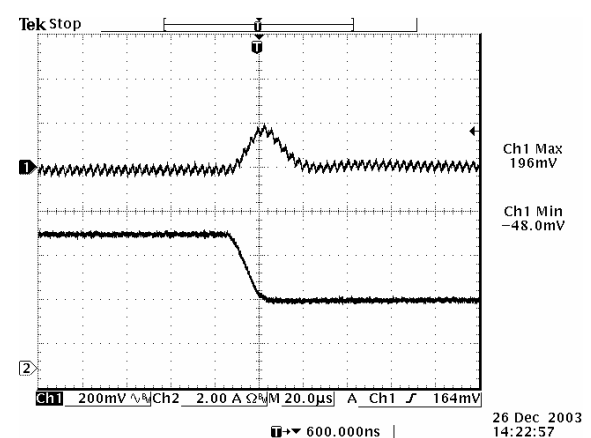

100% to 50% load step at $V_{in}=12\text{ V}$, $V_o=3.3\text{ V}$

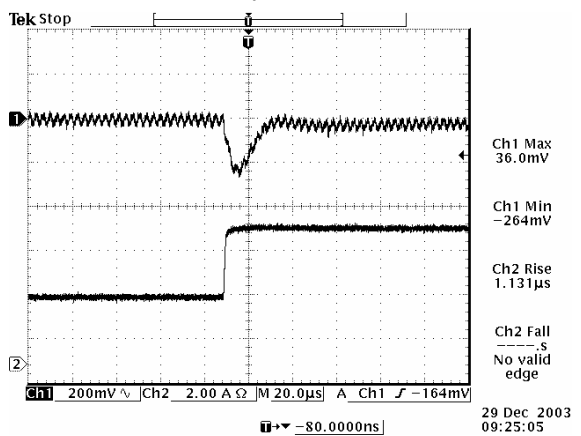

50% to 100% load step at $V_{in}=12\text{ V}$, $V_o=5.0\text{ V}$

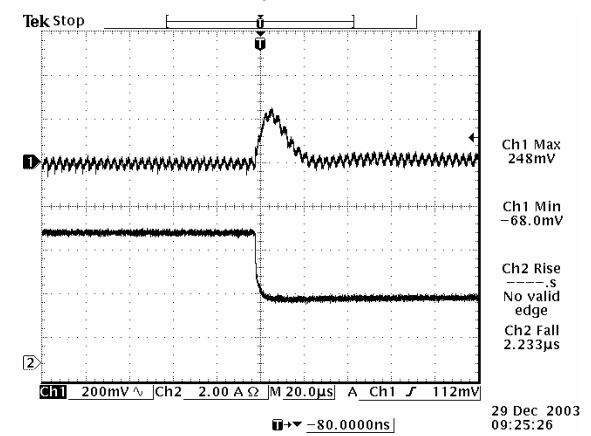

100% to 50% load step at $V_{in}=12\text{ V}$, $V_o=5.0\text{ V}$

Note: Transient response is tested at $di/dt=2.5\text{ A}/\mu\text{S}$, with $10\text{ }\mu\text{F}/10\text{ V}$ tantalum capacitor and $1\text{ }\mu\text{F}/10\text{ V}$ ceramic capacitor, $T_a=25\text{ deg C}$.

NON-ISOLATED DC/DC CONVERTERS

8.3 Vdc - 14 Vdc Input

0.75 Vdc - 5.5 Vdc/6 A Output



Jan. 25, 2013

Bel Power, Inc., a subsidiary of Bel Fuse, Inc.

Mechanical Outline

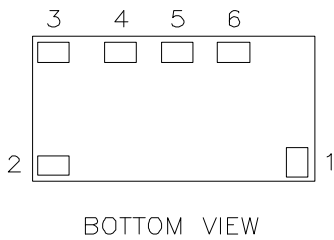
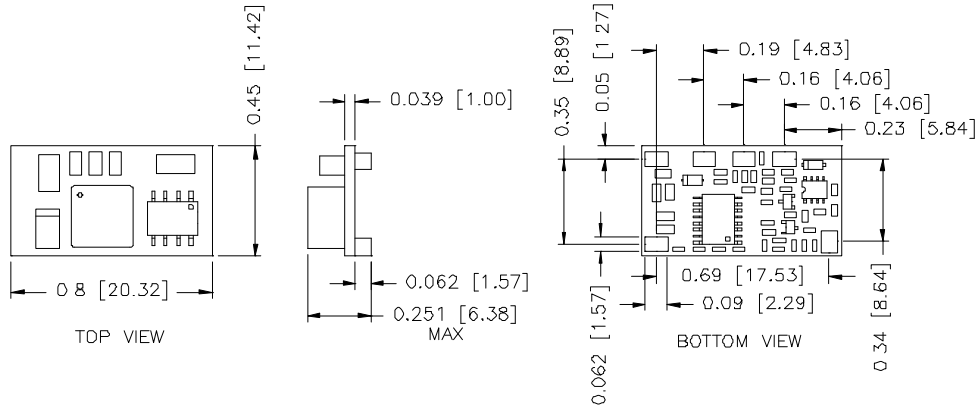

Pin Connections

| Pin | Function |
|-----|---------------|
| 1 | Remote On/Off |
| 2 | Vin+ |
| 3 | SEQ |
| 4 | Ground |
| 5 | Trim |
| 6 | Vout+ |

RECOMMENDED PAD LAYOUT

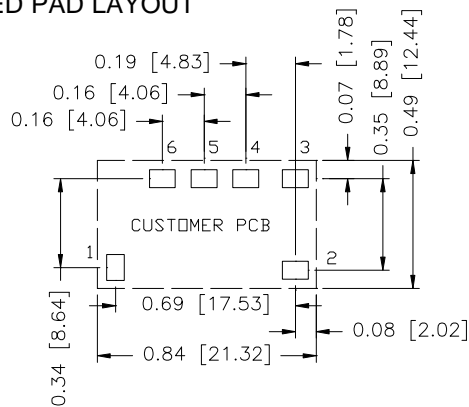

PAD SIZE:
 MIN: 0.12" * 0.095" (3.05mm * 2.41mm)
 MAX: 0.135" * 0.11" (3.43mm * 2.79mm)

Note: These parts are not however compatible with the higher temperatures associated with lead free solder processes and must be soldered using a reflow profile with a peak temperature of no more than 245 °C.

Note:

- 1) All Pins: Material - Copper Alloy;
 Finish – 3 micro inches minimum Gold over 50 micro inches minimum Nickel plate.
- 2) Undimensioned components are shown for visual reference only.
- 3) All dimensions in inches (mm); Tolerances: x.xx +/-0.02 in. (x.x +/-0.5mm) x.xxx +/-0.010 in. (x.xx +/-0.25mm).

NON-ISOLATED DC/DC CONVERTERS

8.3 Vdc - 14 Vdc Input

0.75 Vdc - 5.5 Vdc/6 A Output



Jan. 25, 2013

Bel Power, Inc. , a subsidiary of Bel Fuse, Inc.

Revision History

| Date | Revision | Changes Detail | Approval |
|------------|----------|--|----------|
| 2007-07-12 | A | Change version to A | Lynn |
| 2011-08-25 | B | Update the reflow solder temperature. | HL |
| 2012-7-5 | C | Adding the 7C-III compliance suffix statement. | HL |
| 2013-01-25 | D | Update UL. | HL |

RoHS Compliance

Complies with the European Directive 2002/95/EC, calling for the elimination of lead and other hazardous substances from electronic products.



©2013 Bel Fuse Inc. Specifications subject to change without notice. 012513

CORPORATE

Bel Fuse Inc.
206 Van Vorst Street
Jersey City, NJ 07302
Tel 201-432-0463
Fax 201-432-9542
www.belfuse.com

FAR EAST

Bel Fuse Ltd.
8F/ 8 Luk Hop Street
San Po Kong
Kowloon, Hong Kong
Tel 852-2328-5515
Fax 852-2352-3706
www.belfuse.com

EUROPE

Bel Fuse Europe Ltd.
Preston Technology Management Centre
Marsh Lane, Suite G7, Preston
Lancashire, PR1 8UD, U.K.
Tel 44-1772-556601
Fax 44-1772-888366
www.belfuse.com