

APPLICATION NOTE

MPB125 AC/DC Power Supply Series #M3

Introduction

This specification defines the design and performance characteristics of a single-phase, universal input, power factor corrected, multiple output, 125-watt open frame switch mode power supply. It includes information regarding operational details, cooling requirements, and signal specifications of the power supply.

AC INPUT LINE REQUIREMENTS

The following table defines the voltage and frequency of AC line inputs to the power supply. The power supply is capable of supplying full-rated power in continuous operation throughout the specified ranges of voltages and frequencies. The power supply will automatically recover from AC power loss and shall be capable of startup under peak loading at 90VAC.

	MINIMUM	NOMINAL	MAXIMUM	UNIT
Voltage	90	100 - 240	264	VAC _(RMS)
Frequency	47	-	63	Hz

Table 1

Inrush Current Limiting

Inrush current shall be limited to 24A peak at 115VAC, cold start. Repetitive ON/OFF cycling of the AC input voltage shall not damage the power supply or cause the input fuse to blow.

Input Undervoltage

The power supply contains protection circuitry such that the application of an input voltage below the minimums specified in Table 1 and shall not cause damage to the power supply.

Voltage Hold-Up Time

The power supply will maintain output regulation despite a loss of input power at 100 VAC / 50 Hz and 230 VAC / 47 Hz at maximum continuous output load for a minimum of 17 ms.

Immunity

The power supply, at a minimum, shall pass testing per the limits and methods described in EN55024.

These tests include:

1. Radio Frequency Electromagnetic Field
2. Fast Transients Common Mode
3. Surge Immunity Test
4. Conducted Disturbances Induced by RF Fields
5. Power Frequency Magnetic Field Susceptibility
6. Voltage Dips and Voltage Interruption

REMOTE SENSING

On quad-output models, remote sensing is provided to compensate for voltage drops in the Return and +3.3 V or 2.5 V connections to the load. On dual output models, Remote Sense is provided for the main output. Up to 0.1V in the Return connection (-Sense) and 0.2V in the positive connection (+Sense) may be compensated. The remote sense lines may be connected as follows:

- The -Sense lead should be connected at all times, either at one of the RTN pins of the output connector or at the remote load location.
- When it is desired to use the +Sense lead, connect to the corresponding point at the load.

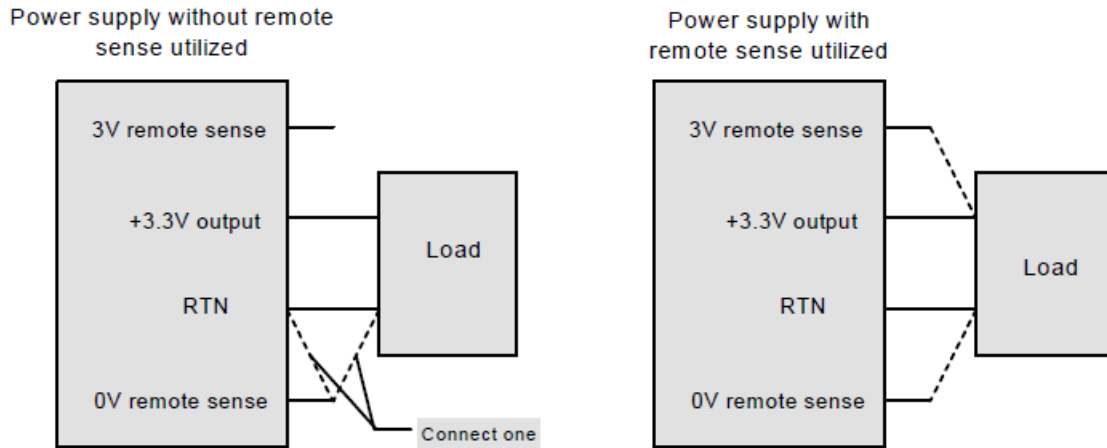

Figure 1

Figure 1 illustrates two possible connection schemes for the remote sense for model # MPB125-4350.

POWER DISTRIBUTION AND LOADING FOR QUAD & TRIPLE OUTPUT MODELS

The following cross-loading diagram (Figure 2) illustrates the maximum power level of each output. Please refer to the following tables and diagrams for specific applications.

The basic cross-loading envelope is formed by rectilinear lines representing the maximum of 80 watts of the combined +5V and +3.3 V / 2.5 V outputs, and the maximum load of 5 Amps for the +12 V output. The upper right corner is limited by the overall power limit of 125 watts.

The graph in the bottom left hand corner indicates that a minimum of 5 watts loading on any combination of the three main outputs is required to guarantee regulation.

The graph at the top left and bottom right corners represent limits of the guaranteed regulation for the +12 V or +5 V outputs. Operation outside these limits is permitted if an additional 1.5% regulation band is acceptable.

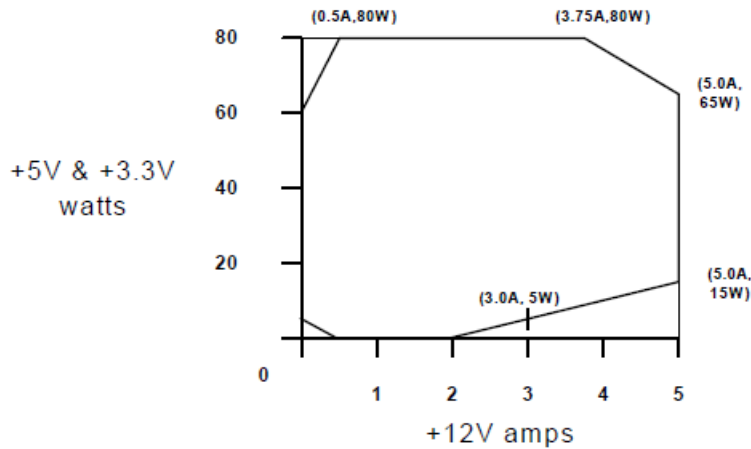

Figure 2

EFFICIENCY

The power supply will meet efficiencies of at least 85% under defined loading conditions specified at 230VAC and 25°C. Efficiency curves are shown in Figure 3.

Voltage	Current
+3.3V	3.7A
+5V	9.4A
+12V	5.0A
-12V	0.5A

Table 2. MPB125-4350

Voltage	Current
+2.5V	3.7A
+5V	9.4A
+12V	5.0A
-12V	0.5A

Table 3. MPB125-4250

Output	Output Power
V1	100W
V2	0A

Table 4. MPB125-2012, MPB125-2024, and MPB125-2048

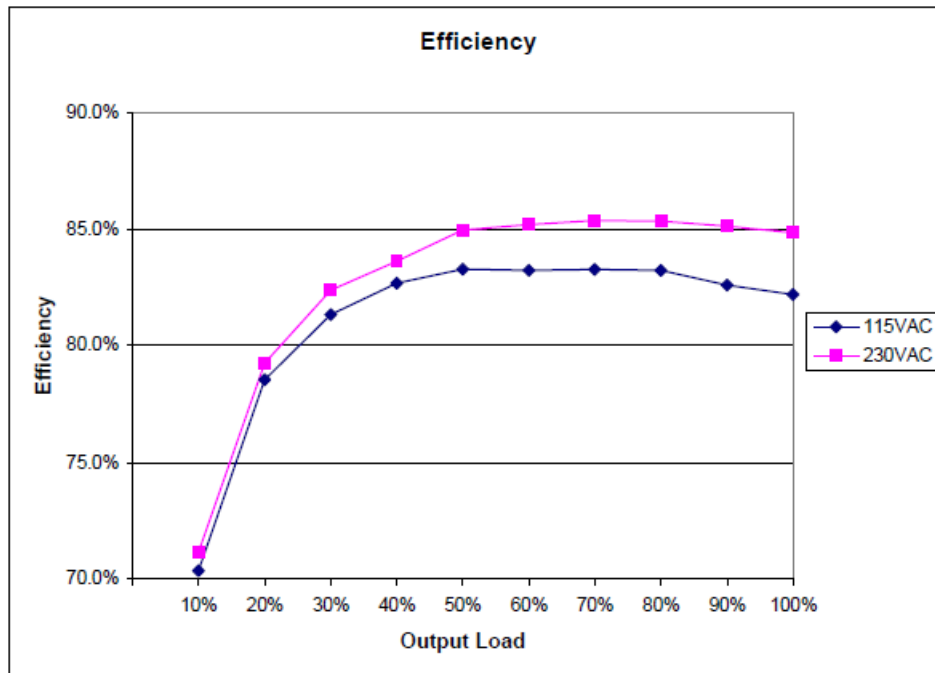

Figure 3

OUTPUT CHARACTERISTICS

Ripple/Noise

Ripple and noise are defined as periodic or random signals over a frequency band of 10 Hz to 20 MHz. Measurements are to be made with an oscilloscope with at least 20 MHz bandwidth. Outputs should be bypassed at the connector with a 0.1 μF ceramic disk capacitor and a 10 μF tantalum capacitor to simulate system loading. Ripple and noise shall not exceed the limits specified in the following table.

Ripple & Noise Limits

The ripple voltage of the outputs shall be measured at the pins of the mating connector using differential measurement or tip and sleeve of a single probe. Ripple specification shall be met under any condition of line voltage and frequency and DC loading.

Output	Maximum Ripple (pk-pk)
+2.5 V	50 mV
+3.3 V	50 mV
+5.05 V	50 mV
+12 V	120 mV
-12 V	120 mV
+24 V	240 mV
+48 V	480 mV

Table 5

RIPPLE/NOISE TEST SETUP

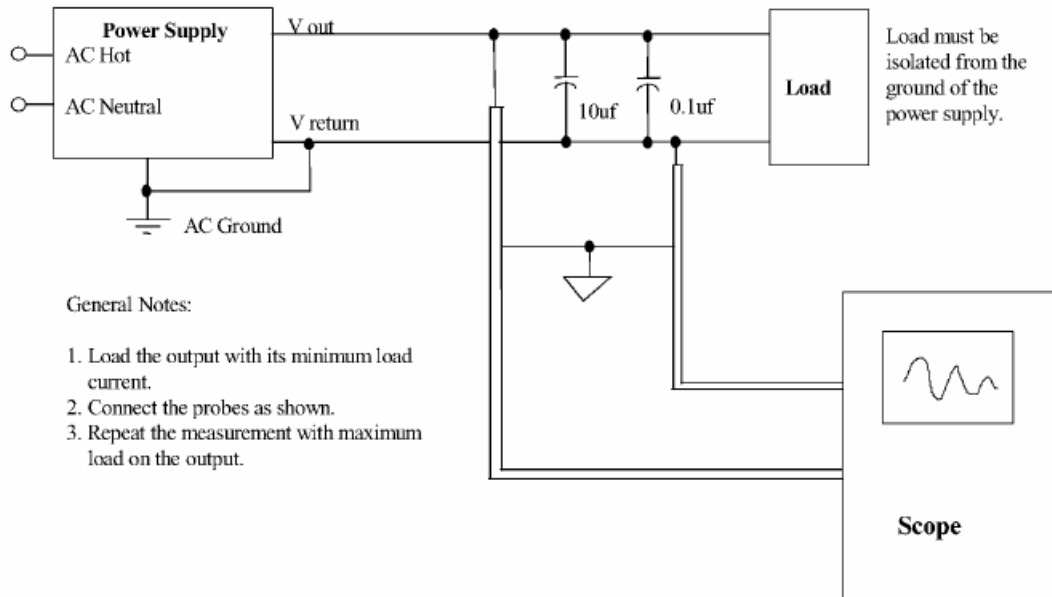

Figure 4

For additional details on how to measure differential noise and ripple, please see Apps Note # A5.

Output Transient Response

The maximum output voltage transient caused by step load changes shall not exceed the established output voltage regulation limits. The power supply shall be stable when subjected to the load transients described below:

- Load changes of 25% on any output, with power supply at 75% loading.
- Load changing repetition of 50 Hz to 333 Hz.
- Transient load slew rate = 1.0 A/usec
- AC input range as specified in Table 1
- Capacitive loading per Table 5.

Capacitive Load

The power supply will power up and operate normally with the following capacitances listed in Table 6 simultaneously present on the DC outputs.

Output	Capacitive Load (μF)
+2.5V MPB125-4250	6.000 μF
+3.3V MPB125-4350	6.000 μF
+5.V Quad and triple models	10.000 μF
+12V Quad and triple models	1.000 μF
-12V Quad and triple models	350 μF
+12V Main MPB125-2012	4.000 μF
+24V MPB125-2024	2.000 μF
+48V MPB125-2048	1.000 μF
+12V Aux. Dual Output models	350 μF

Table 6

+5 V / +3.3 V POWER SEQUENCING FOR MPB125-4350

The +12 V and +5 V output levels are equal to or greater than the +3.3 V output at all times during power up and normal operation. The time between the +12 V or +5 V output reaching minimum in-regulation level and the +3.3 V reaching minimum in-regulation level must be <= 25 ms.

POWER SUPPLY TIMING

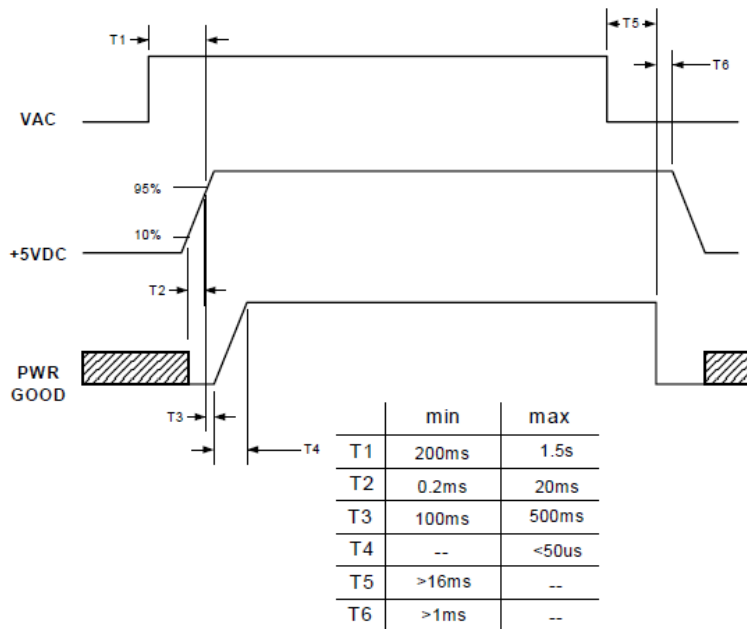

Figure 5



Asia-Pacific
+86 755 298 85888

Europe, Middle East
+353 61 225 977

North America
+1 408 785 5200

Output Rise Time

All output voltages shall rise from 10% of nominal to within regulation range within 0.2 ms to 20 ms. The output voltages waveform shall be a monotonic ramp from 10% to 90% of the regulation band under any loading conditions specified in Figure 2. The monotonic ramp condition requires that the turn-on waveform be positive and have a value of between 0 V/ms and $[V_{out\ nominal}/0.1]$ V/ms. For any 5ms segment of the rise time waveform, a straight line drawn between the end points of the waveform segment must have a positive slope $[V_{out\ nominal}/20]$ V/ms.

POWER GOOD SIGNAL

The Power Good Signal shall provide a logic “high” level to indicate that sufficient time has transpired for the DC outputs to be within their regulation limits. This delay time ensures that sufficient primary side energy is stored by the power supply for continuous power operation within specified hold-up time. When the AC power is removed for a period longer than 16 ms, the Power Good Signal will go to a logic “low” level. The specifications for the Power Good output are contained in Table 7.

Signal Type	+5VDC, TTL compatible
Logic Level “Low”	<0.4V when sinking 4mA
Logic Level “High”	Between 2.4V and 5V when sourcing 200 uA
High State Output Impedance	2Kohm from output to +5V
Power On Delay	Between 100 and 500ms after DC outputs reach 97% of nominal
Power Down Warning	>1ms before +5V and +3.3V or the main output reach 97% of nominal
Rise Time	<50uS from 10% to 90% point.

Table 7

OVERSHOOT AT TURN ON/TURN OFF

The output voltage overshoot upon the application or removal of the input mains voltage shall be less than 10% above the nominal voltage. No voltage of opposite polarity shall be present on any output during turn on or turn off.

OUTPUT PROTECTION

Reset After Shutdown

If the power supply latches off because of fault condition on its outputs, the power supply will return to normal operation only after the fault is removed; the power supply will then restart automatically after < 7 seconds.

Short-Circuit Protection

A short circuit is defined as an impedance of <0.1ohm placed between the DC return and any output. A short circuit will cause no damage to the power supply and will cause it to shutdown. The power supply will attempt a restart every 3 to 7 seconds until the short-circuit condition is removed. After removal of the short circuit, the power supply will maintain normal operations. A short circuit on the -12 V output in the quad and triple models will not cause the power supply to shut down; however, after the short circuit is removed, the -12 V output will resume normal operation. The same short circuit characteristic applies to the auxiliary +12 V output of the dual output models.

No Load Operation

The power supply will operate with no load on all outputs with no damage or hazardous condition. The power supply will remain stable and restart normally after application of loads.

CAUTION

If the load cable has been removed, turn OFF AC mains switch to reconnect loads.

Overcurrent Protection

Overload currents applied to each tested output will cause the output to trip before reaching or exceeding the SELV level of 240 VAC. For testing purposes the overload current should be ramped at a minimum rate of 10A/s starting from full load.

OUTPUT BYPASS

The output return (DC return) may be connected to the power supply chassis at the plated thru mounting hole near the input connector. Mounting hardware should not exceed 0.282 inches in diameter for any lock washer, flat washer, standoff, screw head or other mounting hardware.

COOLING REQUIREMENTS

The power supply can be used under certain output loading conditions in natural convection cooling or with forced air-cooling.

Natural Convection

The recommended maximum continuous output rating of all DC outputs combined at 50°C ambient is 70 watts. Under natural convection cooling, the maximum continuous rating of +3.3 V and +5 V outputs of MPB125-4350, or 2.5 V and 5 V outputs on MPB125-4250 is 40 watts. For the +5 V output of MPB125-3000, the maximum natural convection rating is 60 watts.

Forced Air Cooling

The maximum continuous rating of all DC outputs combined is 125 watts with a minimum of 5 CFM of forced-air cooling through a cross-sectional area of 1.25" x 3.00". For the quad output models, the maximum continuous rating of V1 and V2 is 80 watts. The recommended air flow direction is from input to output.

MPB125 Thermal Testing Procedures

For proper cooling, the unit must be in an enclosure measuring 0.25 inch wider and 0.135 inch above the top of the unit. Thermal measurements are taken in a 3.5" x 1.6" x 12.0" (88.9 mm x 40.6 mm x 304.8 mm) wind tunnel (Figure 6). The power supply must be on standoffs that bring the bottom of the PCB 0.375 inches from the bottom of the enclosure. A minimum of 5 CFM of airflow must be measured from the back end of the enclosure. The proper way to measure airflow is to measure 6 evenly spaced points behind the unit and average them (Figure 7). The unit can run with airflow from any of the four directions. The recommended air flow direction is from the AC input to DC output. Attached are the temperature results from the thermal tests. Component temperatures are shown for various orientations.

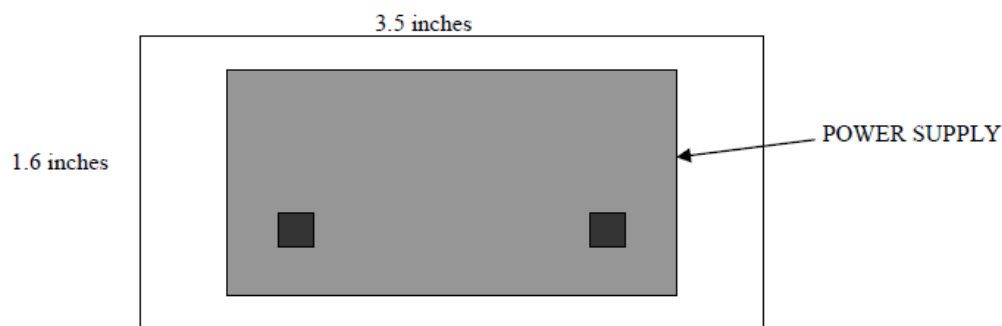

Figure 6. Measure Airflow from 6 Evenly-Spaced Points Behind the Unit

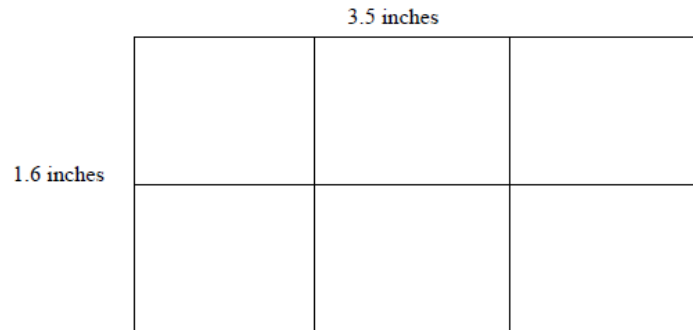

Figure 7

ELECTROMAGNETIC COMPATIBILITY

EMI

The power supply complies with EN55022 CISPR22 Class B in conducted emissions with a -4dB guard band.

Input Line Current Harmonics

The power supply shall comply with EN61000-3-2.

RELIABILITY

Component Derating

The following component derating guidelines shall be followed:

- Semiconductor junction temperatures shall not exceed 110°C with an ambient of 50°C.
- Inductor winding temperatures shall not exceed safety agency requirements.
- Capacitor case temperatures shall not exceed 95% of rated temperature.
- Resistor power dissipation derating shall be greater than 30%.
- Component voltage and current derating shall be greater than 10% at 40°C.

Mean Time Between Failures (MTBF)

The calculated MTBF of the power supply shall be equal to or greater than 200,000 hours of continuous operation at 25°C, subject to maximum output loading and worst case input line voltage, while meeting the specified output requirements at an 80% confidence level. The MTBF of the power supply shall be calculated in accordance with Bellcore, TR-332, Issue 6.