

NON-ISOLATED DC/DC CONVERTERS

10.8 Vdc - 13.2 Vdc Input 0.6 Vdc - 5.0 Vdc/80 A Output



VRP4-80A1Ax

RoHS Compliant

Rev.B

- Non-Isolated
- High Efficiency
- Fixed Switching Frequency
- Low Cost
- Excellent Thermal Performance
- Output Voltage Trim
- Current Share
- Output Over-Voltage Shutdown
- OCP/SCP
- Low Output Ripple
- Power Good Signal
- Remote On/Off
- Over Temperature Protection

Description

The VRP4-80A1Ax is a non-isolated dc/dc converter that operates from a nominal 12 Vdc source. This unit can provide a precisely regulated output voltage from 0.6 Vdc to 5.0 Vdc and can deliver up to 80 A of output current. This unit is designed to be highly efficient and low cost. The converter is provided in an industry standard package.

Part Selection

Output Voltage	Input Voltage	Max. Output Current	Max. Output Power	Typical Efficiency (Vo=3.3 Vdc)	Model Number Active High	Model Number Active High
0.6 V - 5.0 V	10.8 V - 13.2 V	80 A	400 W	93%	VRP4-80A1A0	VRP4-80A1AB ¹

Notes: 1. VRP4-80A1A0 and VRP4-80A1AB are with different heatsink.

2. All part numbers above indicate RoHS 6. Change the second letter "R" to "7" for RoHS 5 part numbers.

3. Add "G" suffix at the end of the model numbers listed above to indicate "Tray Packaging".

Absolute Maximum Ratings

Parameter	Min	Typ	Max	Notes
Input Voltage (continuous)	-0.3 V	-	15 V	
Output Enable Terminal Voltage	-0.3 V	-	15 V	
Ambient Temperature	0 °C	-	70 °C	
Storage Temperature	-55 °C	-	125 °C	

Input Specifications

Parameter	Min	Typ	Max	Notes
Input Voltage	10.8 V	12 V	13.2 V	
Input Current (full load)	-	-	40 A	
Input Reflected Ripple Current (pk-pk)	-	20	35	With simulated source impedance of 1 uH, 5 Hz to 20 MHz. Use a 1000 uF/16 V electrolytic capacitor with ESR=0.1 ohm max, at 100 kHz at 25°C.
Input Reflected Ripple Current (rms)	-	5	10	
I ² t Inrush Current Transient	-	-	1 A ² s	
Turn-on Voltage Threshold	-	10.2 V	10.6 V	
Under Voltage Threshold	-	9.5 V	10 V	

Note: All specifications are typical at 25 °C unless otherwise stated.

NON-ISOLATED DC/DC CONVERTERS

10.8 Vdc - 13.2 Vdc Input 0.6 Vdc - 5.0 Vdc/80 A Output



Output Specifications

Parameter	Min	Typ	Max	Notes	
Output Voltage Set Point Vo ≥ 1 V Vo < 1 V	-1.5 % Vo -10 mV	- -	+1.5 % Vo +10 mV	Vin=Vinmin, Io=Iomax	
Load Regulation Vo ≥ 2.5 V Vo < 2.5 V	- -	- -	0.6% Vo 12 mV		
Line Regulation Vo ≥ 2.5 V Vo < 2.5 V	- -	- -	0.3% Vo 9 mV		
Regulation Over Temperature (0 °C to +70 °C)	-	-	0.02% Vo/C		
Output Current	0 A	-	80 A		
Current Limit Threshold	90 A	110 A	150 A		
Output Ripple and Noise (pk-pk) Vo=5.0 V Vo=3.3 V Vo=2.5 V Vo=1.5 V Vo=1.0 V Vo=0.6 V	- - - - - -	- - - - - -	80 mV 80 mV 60 mV 60 mV 50 mV 50 mV	Test conditions: 0-20 MHz BW, with a 1 µF ceramic capacitor and a 10 µF Tantalum cap at output.	
Output Ripple and Noise (rms) Vo=5.0 V Vo=3.3 V Vo=2.5 V Vo=1.5 V Vo=1.0 V Vo=0.6 V	- - - - - -	- - - - - -	40 mV 40 mV 30 mV 30 mV 25 mV 25 mV		
Turn On Time	-	-	10 mS		
Rise Time	-	-	3 mS		
Overshoot at Turn on and off	-	-	0.5%		
Output Capacitance ESR ≥ 1 mΩ	0 µF	-	4700 µF		
Transient Response					
50% ~ 100% Max Load	Vo=All	-	-	300 mV	Test conditions: di/dt = 2.5 A/µS; Vin =12 V; Ta=25°C, Co=4700 µF.
Settling Time		-	-	100 µS	
100% ~ 50% Max Load		-	-	300 mV	
Settling Time		-	-	100 µS	

Note: All specifications are typical at 25 °C unless otherwise stated.

NON-ISOLATED DC/DC CONVERTERS

10.8 Vdc - 13.2 Vdc Input 0.6 Vdc - 5.0 Vdc/80 A Output



General Specifications

Parameter	Min	Typ	Max	Notes
Efficiency				Measured at Vin=12 V, full load.
Vo=5.0 V	91%	95%	-	
Vo=3.3 V	89%	93%	-	
Vo=2.5 V	88%	92%	-	
Vo=1.8 V	86%	90%	-	
Vo=1.5 V	85%	89%	-	
Vo=1.2 V	81%	86%	-	
Vo=1.0 V	79%	83%	-	
Vo=0.6 V	70%	75%	-	
Switching Frequency	-	250 kHz	-	
Output Voltage Trim Range	0.6 V	-	5 V	Trim pin is open, Vo = 0.6 V.
Over Voltage Protection	110% Vo,set	115%Vo,set	130%Vo,set	Vin=12 V, Io=full load.
Over Temperature Protection	-	105 °C	-	The temperature of heatsink.
MTBF	TBD			Calculated Per Bell Core SR-332 (Io = 80%Iomax; Vin=12 V; Ta = 25 °C)
Dimensions				VRP4-80A1A0
Inches (L x W x H)	2.58 x 1.25 x 0.763			
Millimeters (L x W x H)	65.53 x 31.75 x 19.38			
Dimensions				VRP4-80A1AB
Inches (L x W x H)	2.58 x 1.25 x 0.608			
Millimeters (L x W x H)	65.53 x 31.75 x 15.44			
Weight	-	TBD	-	

Note: All specifications are typical at 25 °C unless otherwise stated.

Control Specifications

Parameter	Min	Typ	Max	Notes
Remote On/Off (Active High)				
Signal Low (Unit Off)	-0.3 V	-	0.8 V	Remote On/Off pin is open, unit is off.
Signal High (Unit On)	2 V	-	Vin,max	
Current Source/Sink	0 mA	-	3.3 mA	
PwGood (PowerGood)				
PwGood = High = Power Good	2.4 V	-	5.25 V	
	-	-	2 mA	
PwGood = Low = Power Not Good	0 V	-	0.4 V	
	-	-	4 mA	

Output Trim Equation

The Trim resistor should be connected between the Trim+ pin and Trim- pin.

$$R_{trim} = \frac{1.2}{V_o - 0.6} (K\Omega)$$

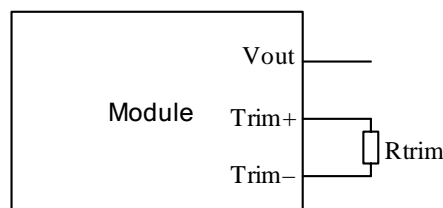

NON-ISOLATED DC/DC CONVERTERS

10.8 Vdc - 13.2 Vdc Input 0.6 Vdc - 5.0 Vdc/80 A Output



Efficiency Data

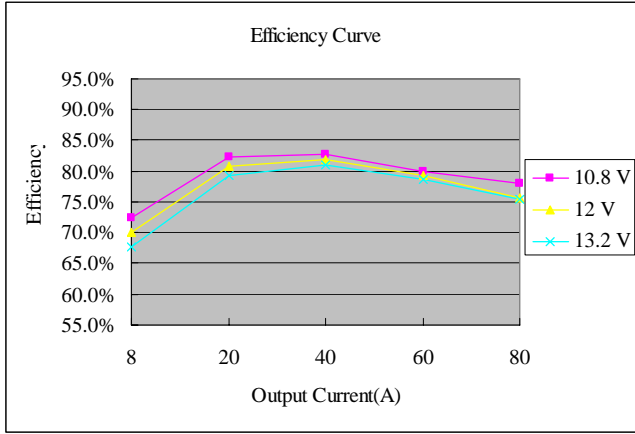

$V_o=0.6\text{ V}$

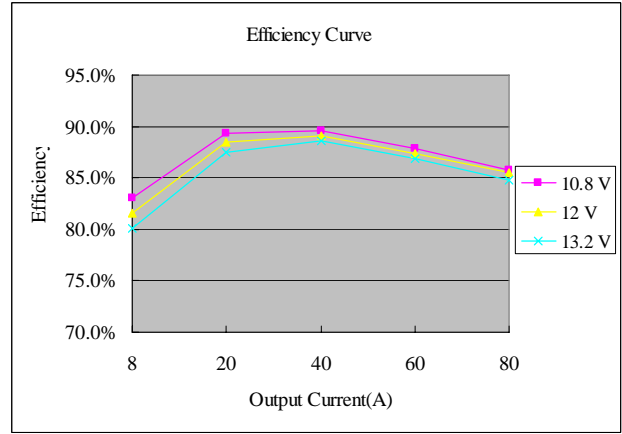

$V_o=1.2\text{ V}$

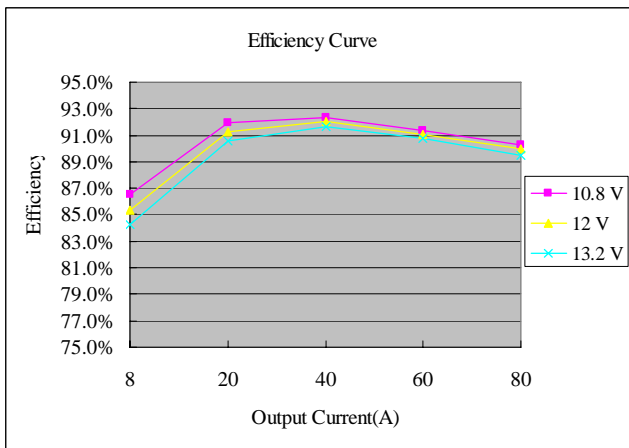

$V_o=1.8\text{ V}$

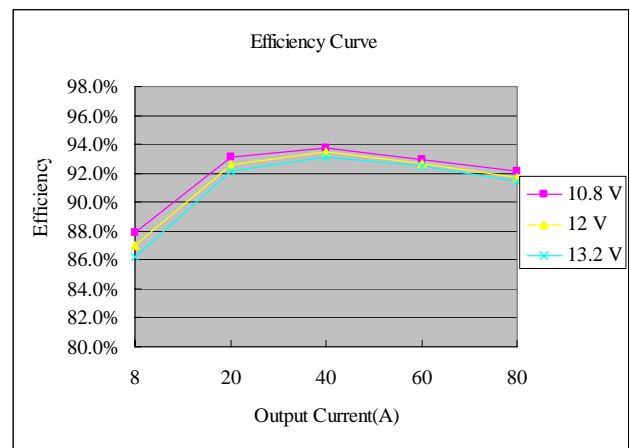

$V_o=2.5\text{ V}$

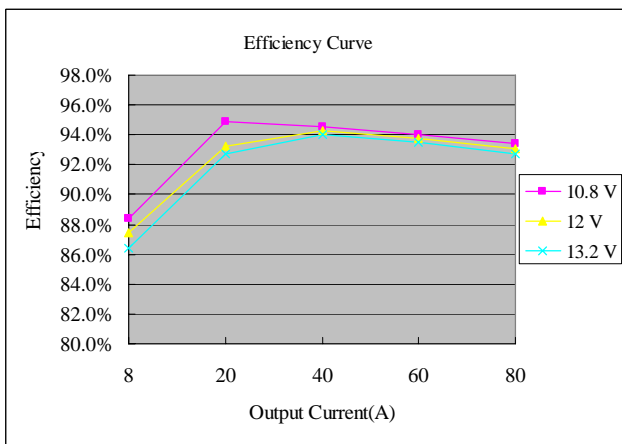

$V_o=3.3\text{ V}$

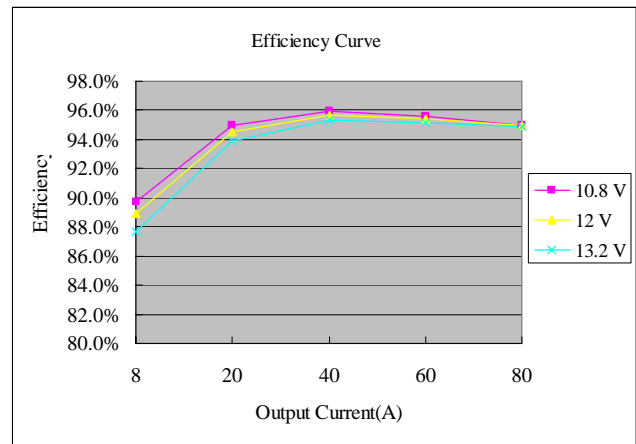

$V_o=5.0\text{ V}$

NON-ISOLATED DC/DC CONVERTERS

10.8 Vdc - 13.2 Vdc Input 0.6 Vdc - 5.0 Vdc/80 A Output



Thermal Derating Curves

VRP4-80A1A0

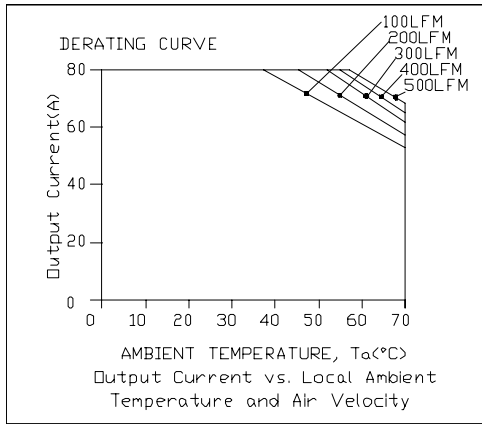

Vo=1.2 V

VRP4-80A1AB

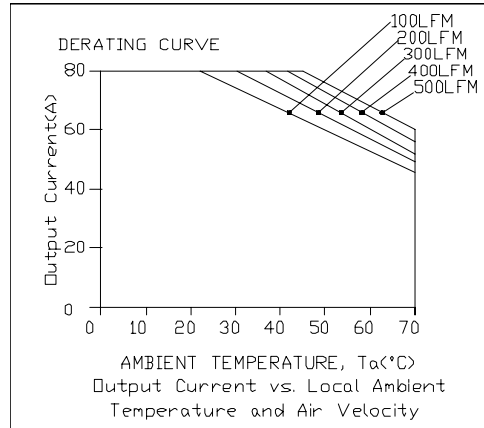

Vo=1.2 V

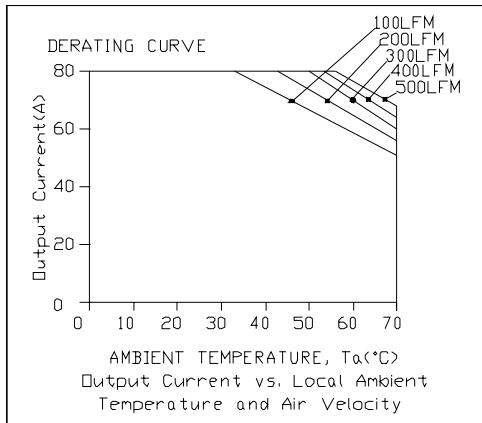

Vo=3.3 V

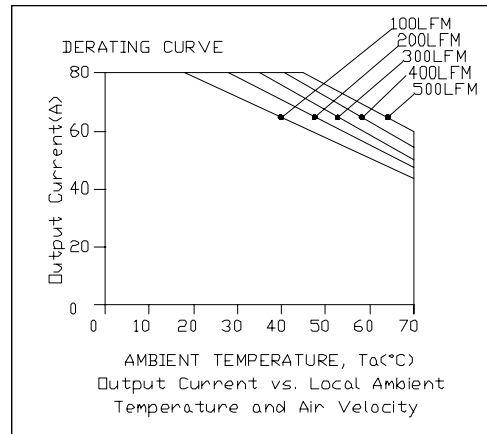

Vo=3.3 V

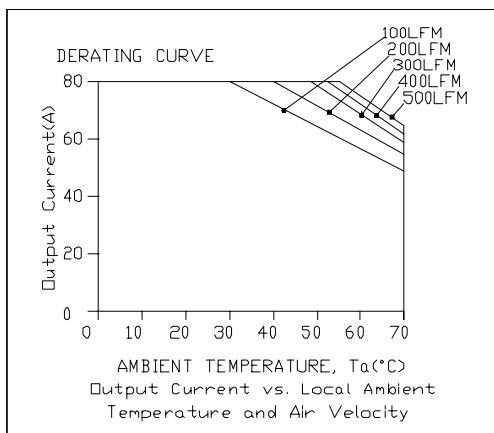

Vo=5.0 V

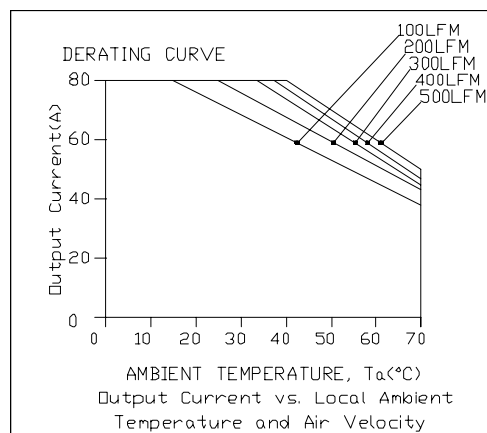

Vo=5.0 V

NON-ISOLATED DC/DC CONVERTERS

10.8 Vdc - 13.2 Vdc Input 0.6 Vdc - 5.0 Vdc/80 A Output



Ripple and Noise Waveforms

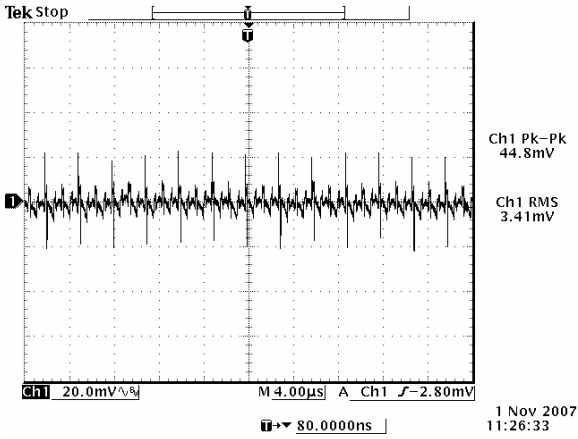

12 Vdc input, 0.6 Vdc/80 A output

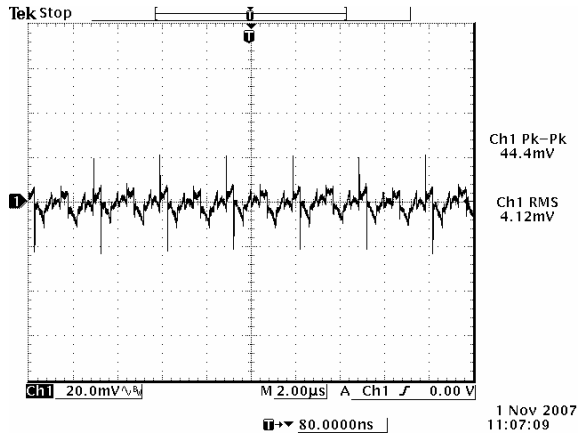

12 Vdc input, 1.2 Vdc/80 A output

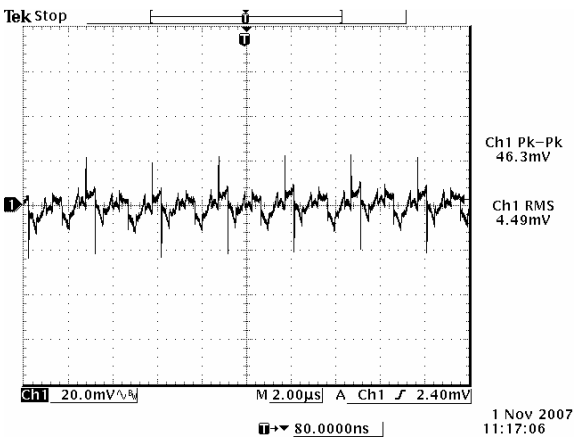

12 Vdc input, 1.5 Vdc/80 A output

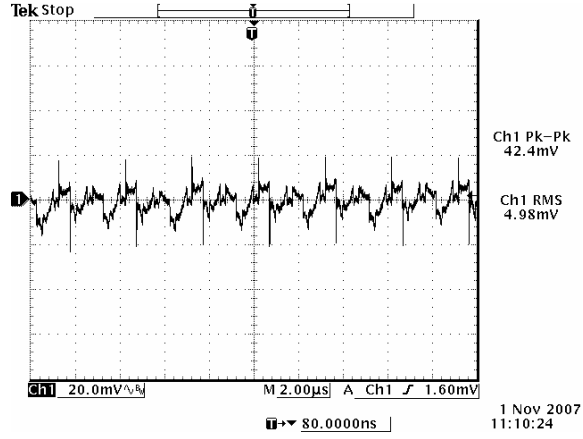

12 Vdc input, 1.8 Vdc/80 A output

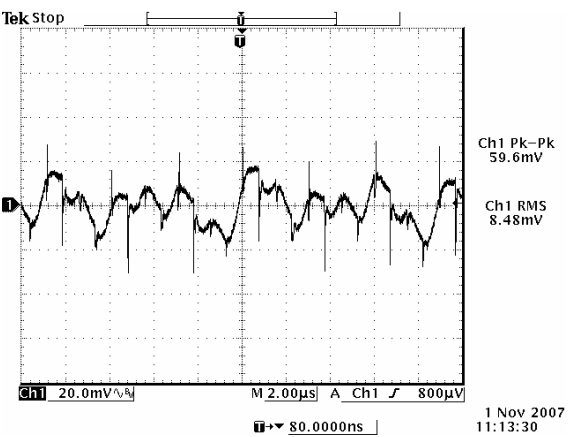

12 Vdc input, 2.5 Vdc/80 A output

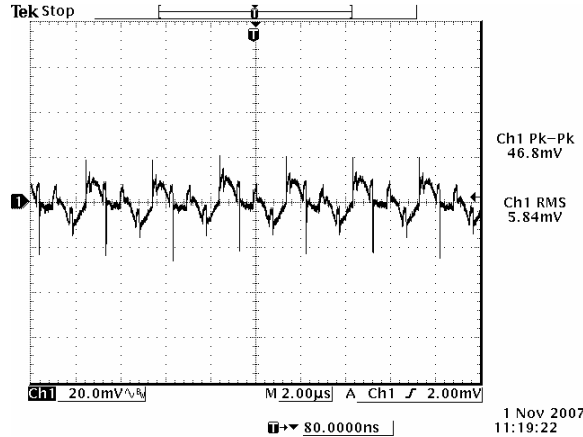

12 Vdc input, 3.3 Vdc/80 A output

NON-ISOLATED DC/DC CONVERTERS

10.8 Vdc - 13.2 Vdc Input 0.6 Vdc - 5.0 Vdc/80 A Output



Ripple and Noise Waveforms (continued)

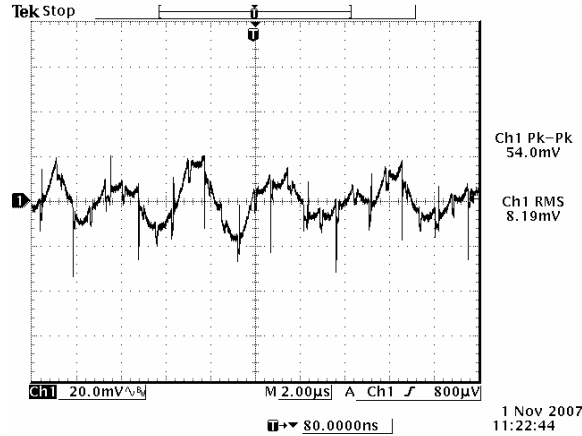

12 Vdc input, 5.0 Vdc/80 A output

Note: Ripple and noise at full load, 0-20 MHz BW, with a 10 μ F tantalum cap and a 1 μ F ceramic cap at the output, and $T_a=25$ deg C.

Transient Response Waveforms

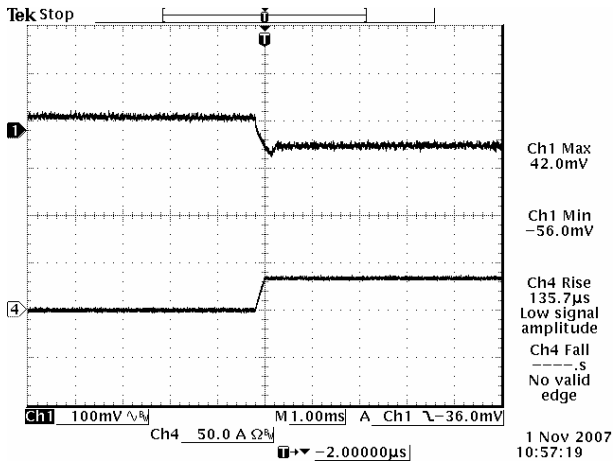

Vout= 0.6 V 0%-50% Load Transients

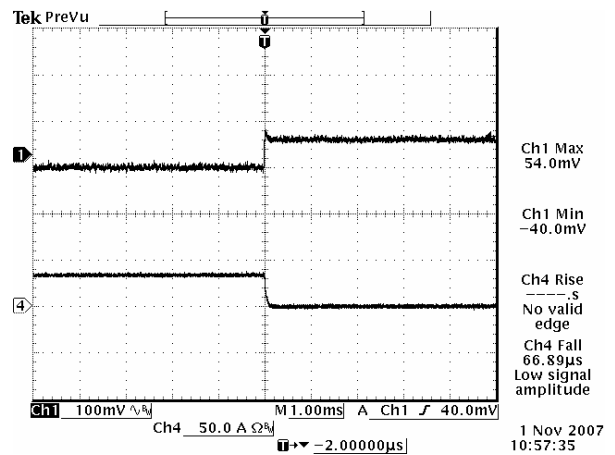

Vout=0.6 V 50%-0% Load Transients

NON-ISOLATED DC/DC CONVERTERS

10.8 Vdc - 13.2 Vdc Input 0.6 Vdc - 5.0 Vdc/80 A Output



Transient Response Waveforms (continued)

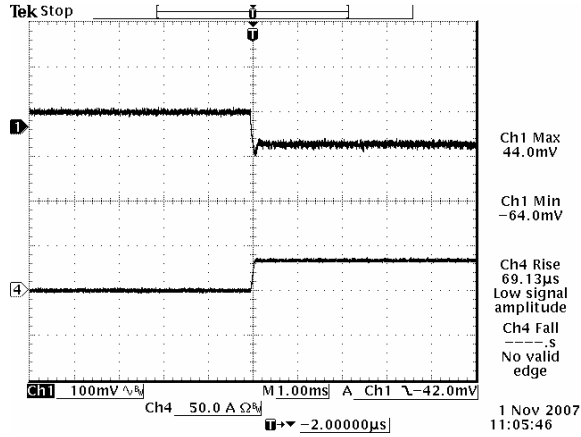

Vout=1.2 V 0%-50% Load Transients

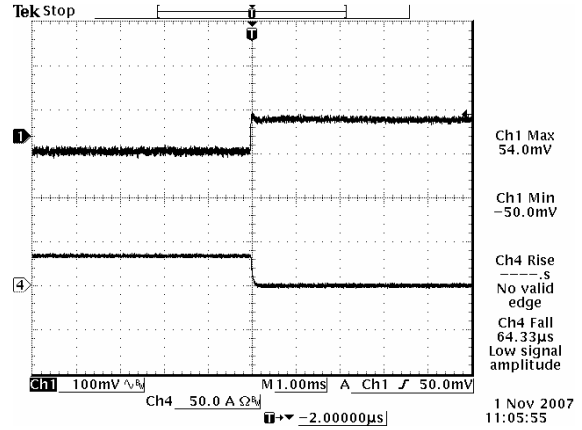

Vout=1.2 V 50%-0% Load Transients

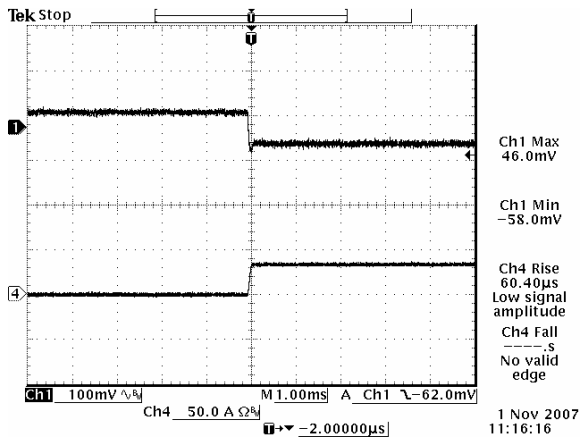

Vout=1.5 V 0%-50% Load Transients

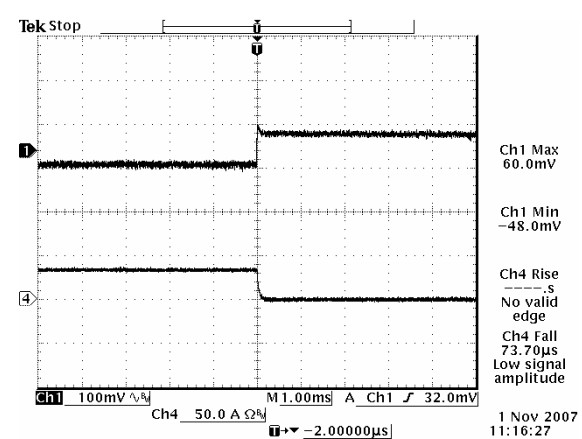

Vout=1.5 V 50%-0% Load Transients

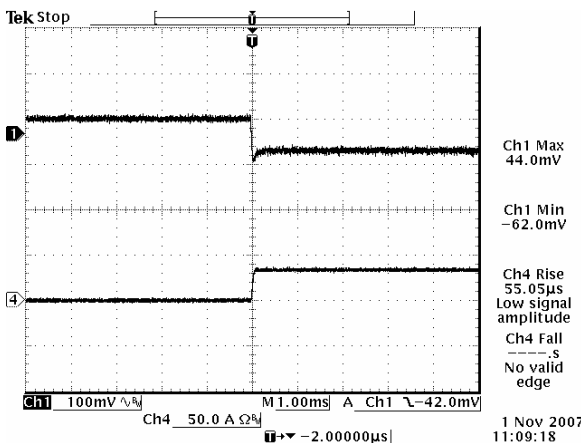

Vout= 1.8 V 0%-50% Load Transients

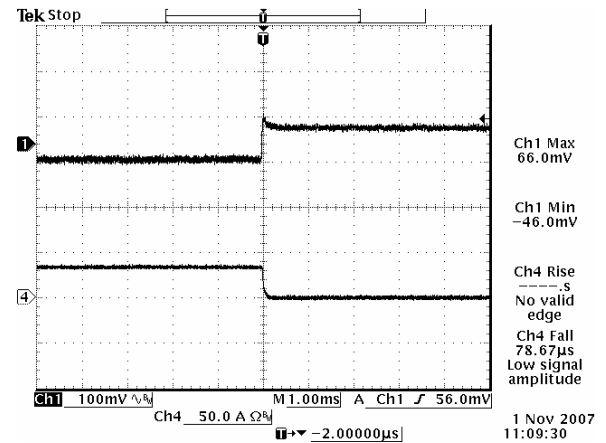

Vout=1.8 V 50%-0% Load Transients

NON-ISOLATED DC/DC CONVERTERS

10.8 Vdc - 13.2 Vdc Input 0.6 Vdc - 5.0 Vdc/80 A Output



Transient Response Waveforms (continued)

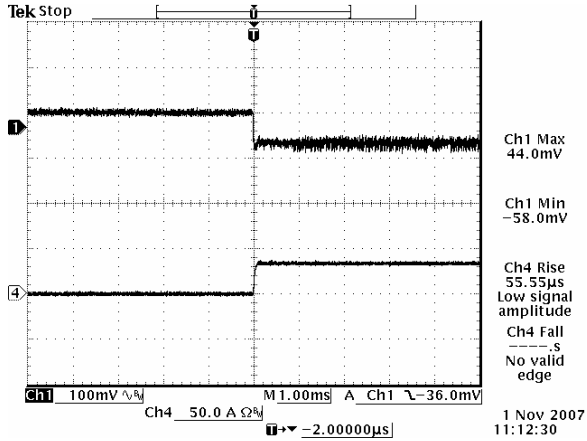

Vout=2.5 V 0%-50% Load Transients

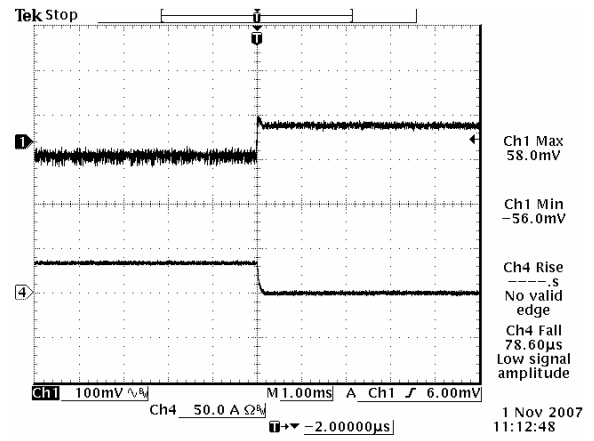

Vout=2.5 V 50%-0% Load Transients

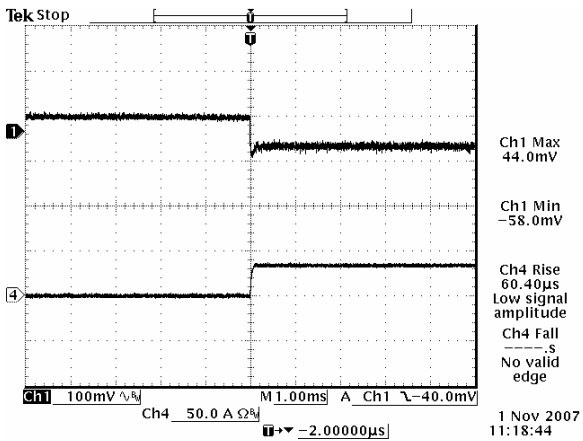

Vout=3.3 V 0%-50% Load Transients

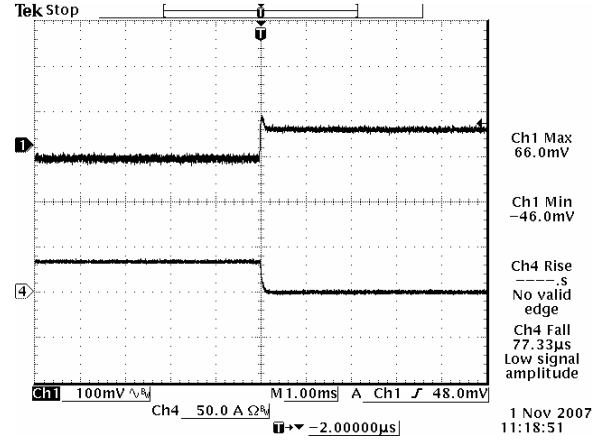

Vout=3.3 V 50%-0% Load Transients

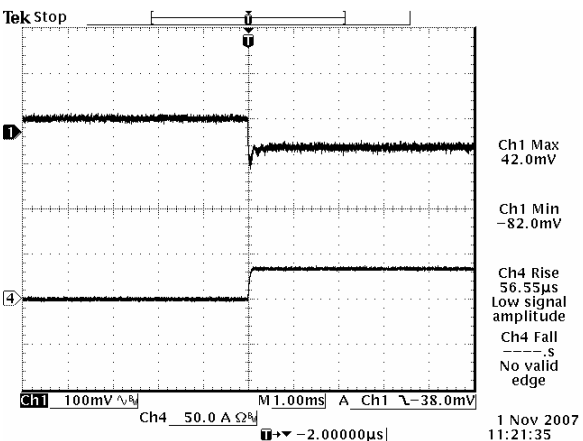

Vout=5 V 0%-50% Load Transients

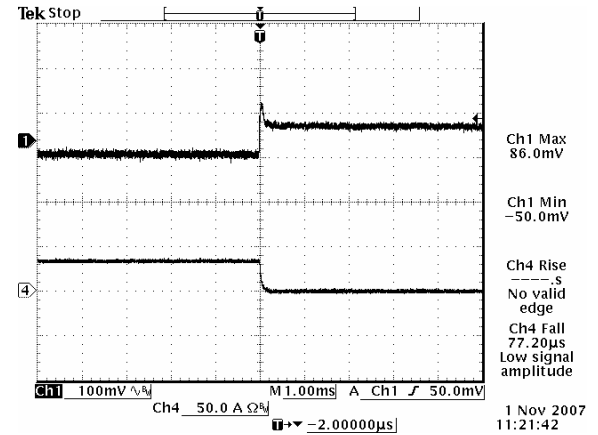

Vout=5 V 50%-0% Load Transients

Note: Transient response at $di/dt = 2.5 \text{ A}/\mu\text{s}$, with external electrolytic cap 4700 μF , and $T_a = 25 \text{ deg C}$.

NON-ISOLATED DC/DC CONVERTERS

10.8 Vdc - 13.2 Vdc Input 0.6 Vdc - 5.0 Vdc/80 A Output



Mechanical Outline

VRP4-80A1A0

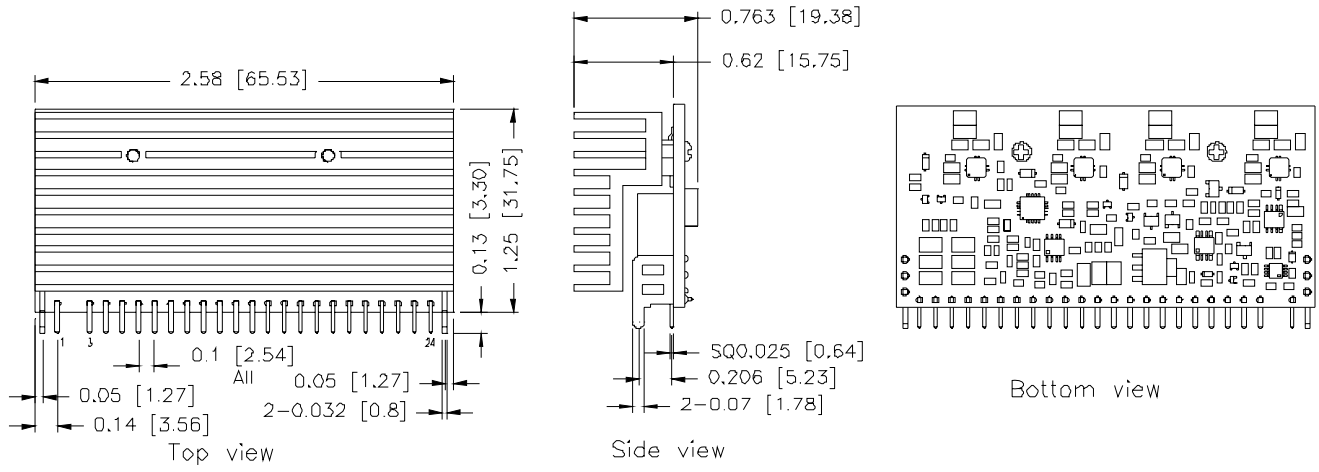

UNIT: INCH [mm]

VRP4-80A1AB

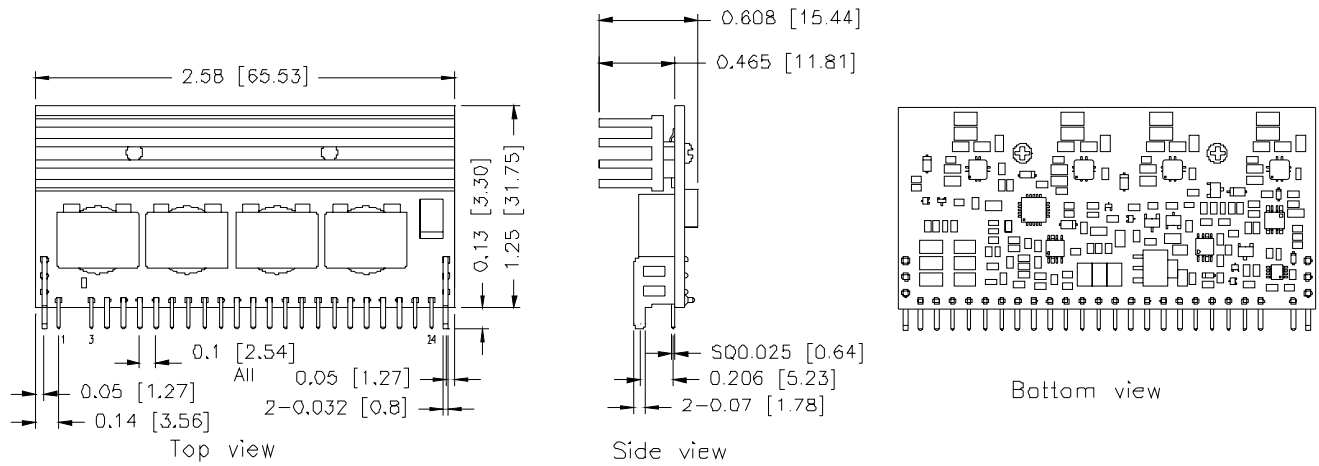

UNIT: INCH [mm]

NON-ISOLATED DC/DC CONVERTERS

10.8 Vdc - 13.2 Vdc Input 0.6 Vdc - 5.0 Vdc/80 A Output



Mechanical Outline (continued)

Pin Connections

Pin	Function	Pin	Function	Pin	Function
1	Trim+	9	Enable	17	GND
2	N/A	10	Sense-	18	Vout
3	GND	11	Sense+	19	GND
4	PwGOOD	12	Vin	20	Vout
5	Trim-	13	Vin	21	GND
6	Ishare	14	Vin	22	Vout
7	GND	15	Vout	23	GND
8	GND	16	Vout	24	Vout

Note: VRP4-80A1A0 and VRP4-80A1AB are with the same pin function.

RECOMMENDED PAD LAYOUT

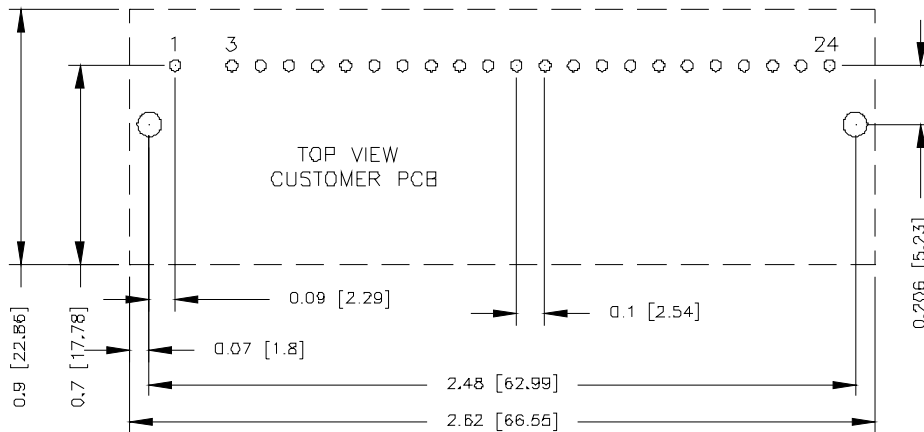

2 SUPPORT PAD THR. HOLES ϕ 0.085 [ϕ 2.2] BOTH SIDE
 2.3 PIN PAD THR. HOLES: ϕ 0.04 [ϕ 1.0] BOTH SIDE

RoHS Compliance

Complies with the European Directive 2002/95/EC, calling for the elimination of lead and other hazardous substances from electronic products.



©2007 Bel Fuse Inc. Specifications subject to change without notice. 110607

CORPORATE

Bel Fuse Inc.
 206 Van Vorst Street
 Jersey City, NJ 07302
 Tel 201-432-0463
 Fax 201-432-9542
www.belfuse.com

FAR EAST

Bel Fuse Ltd.
 8F/ 8 Luk Hop Street
 San Po Kong
 Kowloon, Hong Kong
 Tel 852-2328-5515
 Fax 852-2352-3706
www.belfuse.com

EUROPE

Bel Fuse Europe Ltd.
 Preston Technology Management Centre
 Marsh Lane, Suite G7, Preston
 Lancashire, PR1 8UD, U.K.
 Tel 44-1772-556601
 Fax 44-1772-888366
www.belfuse.com