

INSTALLATION INSTRUCTION

LDX-SC12

Super Capacitors Module



LDX-SC12 INPUT: 0 - 16 VDC, 20 A

MAIN FEATURES

- > 7.6 kJ (2.1 Wh) energy storage
- Replaces 12 V batteries for short term backup applications
- Extended operating temperature for high reliability
- Multiple parallel / series connection possibilities for voltage and/or current increase
- Reverse polarity and overcurrent protections
- Pluggable connectors
- Up to 85°C operating temperature
- Dimensions: 80.0 x 120.0 x 100.0 mm (3.15 x 4.72 x 3.94 in)

READ THIS CAREFULLY BEFORE INSTALLATION!	VOR DER INSTALLATION BITTE FOLGENDE SICHERHEITSHINWEISE BEACHTEN!	LEGGERE ATTENTAMENTE PRIMA DELL'INSTALLAZIONE!	A LIRE ATTENTIVEMENT AVANT L'INSTALLATION!
<p>Before operating, read this document thoroughly and retain it for future reference. Non-respect of these instructions may reduce performances and safety of the devices and cause danger for people and property. The products must be installed, operated, serviced and maintained by qualified personnel in compliance with applicable standards and regulations. Do not open the device, it does not contain replaceable components, the tripping of the internal fuse (if included) is caused by an internal failure. Do not repair or modify the device, if malfunction or failure should occur during operation, send unit to the factory for inspection. No responsibility is assumed by Bel for any consequences deriving from the use of this material.</p>	<p>Lesen Sie dieses Dokument vor der Inbetriebnahme sorgfältig durch und bewahren Sie es zum späteren Nachschlagen auf. Die Nichtbeachtung dieser Anweisungen kann die Funktion und Sicherheit der Geräte beeinträchtigen und birgt Gefahren für Personen und Eigentum. Die Geräte müssen von qualifiziertem Personal unter Einhaltung der geltenden Normen und Vorschriften installiert, betrieben, gewartet und instand gehalten werden. Öffnen Sie das Gerät nicht, es enthält keine austauschbaren Komponenten, das Auslösen der internen Sicherung (falls vorhanden) ist stets auf tiefergehende Fehler im Schaltkreis zurück zu führen. Reparieren oder modifizieren Sie das Gerät nicht. Sollte während des Betriebs eine Fehlfunktion oder ein Defekt auftreten, schicken Sie das Gerät zur Überprüfung ins Werk. Bel übernimmt keine Haftung für die Folgen, die sich aus dem Einsatz dieses Gerätes ergeben.</p>	<p>Prima dell'installazione, leggere attentamente questo documento istruzioni e conservarle per future consultazioni. L'insosservanza delle presenti istruzioni può compromettere le caratteristiche e la sicurezza dell'apparecchio e causare pericolo per le persone e le cose. Il prodotto deve essere installato, utilizzato e riparato da personale qualificato e nel rispetto delle normative vigenti. Non aprire il prodotto, esso non contiene componenti sostituibili, il guasto del fusibile interno (se previsto) è causato da un guasto interno. Non tentare di riparare o modificare il prodotto, se durante il funzionamento si verificano guasti o anomalie, inviarlo al produttore per il controllo. Bel non si assume nessuna responsabilità per qualunque conseguenza derivante dall'uso di questo materiale.</p>	<p>Lire ces instructions avant l'installation, conserver ce manuel pour référence future. Défaut de se conformer à ces instructions peut affecter les caractéristiques et la sécurité du dispositif, et causer du danger aux personnes ou aux biens. Les produits doivent être installés, exploités et entretenus par du personnel qualifié et en conformité avec les règlements. N'ouvrez pas le produit, il ne contient aucune pièce réparable, le déclenchement du fusible interne (le cas échéant) est causé par un défaut interne. Ne pas essayer de réparer ou modifier le produit ; si des défaillances se produisent pendant le fonctionnement, retourner le produit au fabricant pour inspection. Bel n'assume aucune responsabilité des conséquences éventuelles découlant de l'utilisation des produits.</p>
CAUTION	ACHTUNG	ATTENZIONE	AVVERTISSEMENT
<p>RISK OF BURNS, EXPLOSION, FIRE, ELECTRICAL SHOCK, PERSONAL INJURY. Never carry out work on live parts! Danger of fatal injury! The product's enclosure may be hot, allow time for cooling product before touching it. Do not allow liquids or foreign objects to enter into the products. To avoid sparks, do not connect or disconnect the device before having previously turned-off input power and wait for internal capacitors discharge (minimum 1 minute).</p>	<p>GEFAHR VON VERBRENNUNGEN, EXPLOSIONEN, FEUER, STROMSCHLAG, PERSONENSCHÄDEN. Führen Sie niemals Arbeiten an spannungsführenden Teilen durch! Gefahr von tödlichen Verletzungen! Das Gehäuse des Gerätes kann heiß sein, lassen Sie Zeit zum Abkühlen des Gerätes, bevor Sie es berühren. Lassen Sie keine Flüssigkeiten oder Fremdkörper in die Geräte eindringen. Um Überschläge zu vermeiden, schließen Sie das Gerät nicht an oder trennen Sie es nicht ohne vorher die Eingangsspannung abgeschaltet zu haben, und warten Sie die Entladung der internen Kondensatoren ab (mindestens 1 Minute).</p>	<p>RISCHIO USTIONI, ESPLOSIONE, INCENDIO, SCOSSA, LESIONI GRAVI. Non effettuare mai operazioni sulle parti sotto tensione! Pericolo di lesioni letali! Il contenitore può scottare, lasciar quindi raffreddare il dispositivo prima di toccarlo. Non far entrare liquidi o oggetti estranei nel dispositivo. Per evitare scintille, non collegare o scollegare l'apparecchiatura prima di avere tolto tensione di ingresso e prima che sia avvenuta la scarica dei condensatori interni (min. 1 minuto).</p>	<p>RISQUE DE BRULURES, EXPLOSION, INCENDIE, ELECTROCUTION, DOMMAGE AUX PERSONNES. Ne jamais effectuer des opérations sur les parties sous tension! Danger de mort! Le boîtier peut produire des brûlures, le laisser refroidir avant de toucher l'appareil. Ne faire pas pénétrer des liquides ou des corps étrangers dans l'appareil. Pour éviter des étincelles, ne pas connecter ou déconnecter l'équipement jusqu'à ce que la tension d'entrée a été supprimée et avant qu'il n'ait eut lieu la décharge des condensateurs internes (minimum 1 minute).</p>
INTENDED USE	BESTIMMUNGSGEMÄßER BETRIEB	USO PREVISTO	UTILISATION
<p>These are isolated devices suitable for SELV and PELV circuitry and are designed to be mounted on DIN rail and installed inside a protective enclosure. They are intended for general use such as in industrial control, communication, and instrumentation equipment. Do not use these devices in applications where malfunction may cause injury or death.</p>	<p>Es handelt sich um galvanisch getrennte Geräte, die für SELV- und PELV-Anwendungen geeignet sind und für die Montage auf DIN-Schienen und die Installation in einem Schutzgehäuse konzipiert sind. Sie sind für den allgemeinen Gebrauch wie z.B. in industriellen Steuer-, Kommunikations- und Automatisierung-Anwendungen vorgesehen. Verwenden Sie diese Geräte nicht in Anwendungen, bei denen eine Fehlfunktion zu Verletzungen oder zum Tod führen kann.</p>	<p>I dispositivi sono isolati, adatti per applicazioni SELV e PELV, sono dotati di aggancio per il montaggio su guida DIN all'interno di quadri elettrici o contenitori di protezione, per l'utilizzo con controllori industriali, unità di comunicazione o apparecchi di misura. Non utilizzare in applicazioni in cui un eventuale guasto può comportare rischio di lesioni o di morte.</p>	<p>Les produits sont isolés, appropriés pour les circuits TBTS et TBTP et sont équipés d'un crochet pour montage sur rail DIN dans des armoires ou conteneurs de protection, pour utilisation avec les contrôleurs industriels, des modules de communication ou des unités de mesure. Ne pas utiliser ces dispositifs dans une application où un dysfonctionnement pourrait entraîner le risque des blessures ou de mort.</p>
ENVIRONMENTAL CHARACTERISTICS	UMGEBUNGSBEDINGUNGEN	CARATTERISTICHE AMBIENTALI	CARACTÉRISTIQUES ENVIRONNEMENTALES
<p>Installation in a Pollution Degree 2 environment. Do not use in wet area or subject to moisture. Carefully recycle the product and related batteries according to local regulations.</p>	<p>Installation in einer Umgebung mit Verschmutzungsgrad 2. Nicht in nassen Bereichen oder unter Feuchtigkeit verwenden. Das Gerät und die zugehörigen Batterien sind entsprechend den lokalen Vorschriften zu recyceln bzw. zu entsorgen.</p>	<p>Usare in ambienti con Grado di Inquinamento 2. Non far funzionare l'apparecchio in un ambiente umido o soggetto a formazione di condensa. Riciclare il prodotto e le batterie collegate, nel rispetto delle normative locali vigenti.</p>	<p>Utiliser les produits dans des environnements avec degré de pollution 2. Ne pas employer l'appareil dans un environnement humide ou soumis à la condensation. Recycler les produits et les batteries, conformément à la réglementation locale.</p>

INSTRUCTIONS**DESCRIPTION**

Description: LDX-SC12 is a Super Capacitors Module providing up to 7.6 kJ (2.1 Wh) energy storage capability. It can be used to replace batteries for short term backup function.

INSTALLATION

Use DIN-rails according to EN 60715. Installation should be made vertically (see Fig.4). For better device stability fix the rail to the wall close to the point where the device is to be mounted. In order to guarantee sufficient convection, we recommend observing a minimum distance to other modules (see Fig.3).

CONNECTIONS

The device is equipped with pluggable screw terminals. To avoid sparks, do not connect or disconnect the connectors before having previously turned-off input power and waited for capacitors discharge.

In order to comply with local certification, use appropriate copper cables of indicated cross section, designed for operating temperatures of
 60°C for ambient up to 45°C
 75°C for ambient up to 60°C
 90°C for ambient up to 70°C.

Strip the connecting ends of the wires according to the indication on Fig.5 and ensure that all strands of a stranded wire enter the terminal connection.

PROTECTIONS

To prevent damage in case of reverse polarity or short circuit the device is protected by a user replaceable 30 A / 32 V ATO blade fuse.

For continued protection replace with same type and ratings of fuse only. The maximum allowed charge voltage is 16 VDC with a temporary overvoltage of max. 17 VDC. Exceeding these values will decrease product life dramatically and possibly triggering the overvoltage protection leading to fuse failure.

SERIES AND PARALLEL CONNECTION

To increase the backup time and / or the available current several LDX-SC12 can be connected in series / parallel arrangements. From the user point of view the LDX-SC12 is exactly equivalent to a 12V battery so that every series / parallel combination performed with 12V batteries can be done also with LDX-SC12. When used in conjunction with LDD960-UU UPS module the maximum number of LDX-SC12 connectable in series is 3, because of the maximum charge voltage limitation of the LDD960-UU

SAFETY PRECAUTIONS

LDX-SC12 can provide extremely high current when short circuited, **do not short circuit.** A short circuit when the LDX-SC12 is charged will lead to fuse failure. When LDX-SC12 is fully charged at 16 VDC it will remain charged for days, avoid storing or shipping when not fully discharged before; do not short circuit to discharge LDX-SC12. Charging LDX-SC12 at voltage above 17 VDC can lead to severe damage to the unit.

When connecting several LDX-SC12 in series / parallel please discharge every LDX-SC12; **never connect in parallel a charged unit with a discharged unit;** fuses of both units will fail.

OPERATING TEMPERATURE

Operating temperature: is recommended using in the following conditions

-40°C...+85°C when the environmental conditions is above 65°C derating voltage -120 mV/°C

WARRANTY

LDX-SC12 is guaranteed free from factory defects for the time specified in the "Sales Conditions".

Failures caused by misuse, external and/or abnormal events (i.e. overvoltage, over temperatures) or non-respect of above parameters and standards, are not covered by warranty. Opening the housing of the product makes warranty to be no longer valid

See also the products below that can be used in conjunction with LDX-SC12 unit:

- LDC-U20 20 A High performance DC UPS
- LDD960-UU 20 A High performance DC UPS/DC-DC Converter
- LDX-C120 Battery Charger and DC UPS

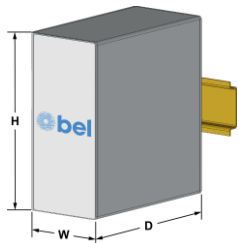
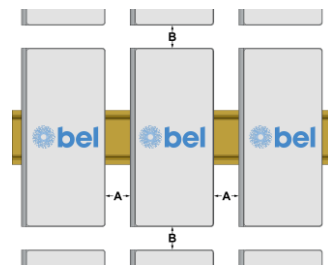
CONNECTIONS		DIMENSIONS	DISTANCES													
	<ol style="list-style-type: none"> 1. Input / Output: double IO connection (parallel) 2. FUSE: 30 A / 32 V ATO blade user replaceable 															
	Input / Output Connection: <ul style="list-style-type: none"> ▪ += Positive DC ▪ -= Negative DC 			<table border="1"> <thead> <tr> <th>Dimension</th> <th>mm</th> </tr> </thead> <tbody> <tr> <td>W</td> <td>80.0</td> </tr> <tr> <td>D</td> <td>120.0</td> </tr> <tr> <td>H</td> <td>100.0</td> </tr> </tbody> </table>	Dimension	mm	W	80.0	D	120.0	H	100.0	<table border="1"> <thead> <tr> <th>Distance</th> <th>mm</th> </tr> </thead> <tbody> <tr> <td>A</td> <td>20</td> </tr> <tr> <td>B</td> <td>20</td> </tr> </tbody> </table>	Distance	mm	A
Dimension	mm															
W	80.0															
D	120.0															
H	100.0															
Distance	mm															
A	20															
B	20															



Manufacturer
 Bel Fuse Inc.
 300 Executive Drive, Suite 300
 West Orange, NJ 07052
 USA

Asia-Pacific
 +86 755 2988 5888

Europe, Middle East
 +353 61 49 8941

North America
 +1 866 513 2839

belfuse.com/power-solutions

© 2023 Bel Fuse Inc.

BCM.00590_E

INPUT / OUTPUT CONNECTIONS

Example of parallel connection system using LDD960-U

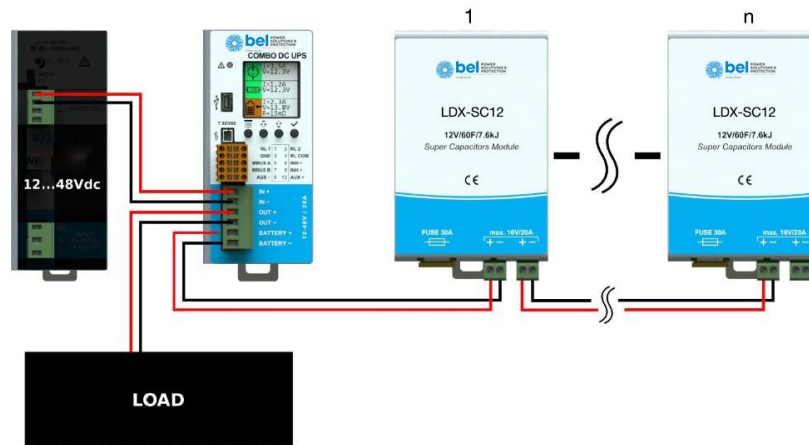

Example of series connection system using LDD960-U

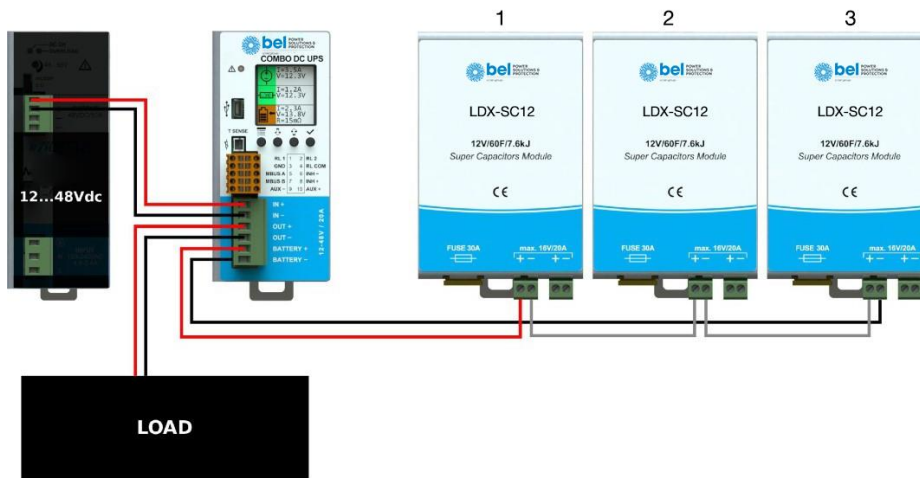

Manufacturer
 Bel Fuse Inc.
 300 Executive Drive, Suite 300
 West Orange, NJ 07052
 USA

Asia-Pacific
 +86 755 2988 5888

Europe, Middle East
 +353 61 49 8941

North America
 +1 866 513 2839

belfuse.com/power-solutions

© 2023 Bel Fuse Inc. BCM.00590_E

MOUNTING / DISMOUNTING INSTRUCTIONS

For DIN rail fastening according to IEC 60715 TH35-7.5(-15)

Mounting as shown in figure, with input terminals on lower side, with suitable cooling and maintaining a proper distance between adjacent devices as specified in the Installation Instruction.

MOUNTING:

1. Tilt the unit slightly backwards.
2. Fit the unit over the top edge of the rail.
3. Slide it downward until it hits the stop.
4. Press against the bottom for locking.

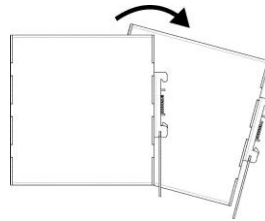

1

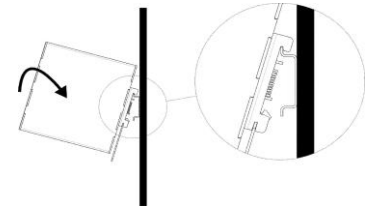

2

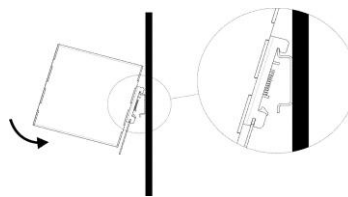

3

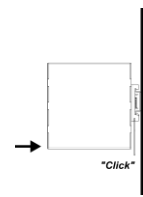

4

DISMOUNTING:

1. Pull down the slide clamp lever
2. Tilt the unit upward
3. Unhook the unit from the rail

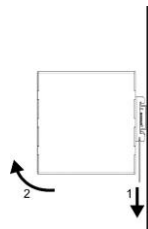

1 & 2

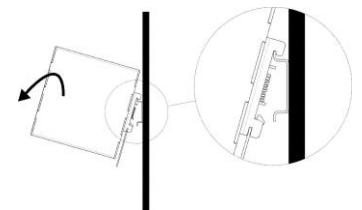

3

RECOMMENDED CONNECTING CABLE

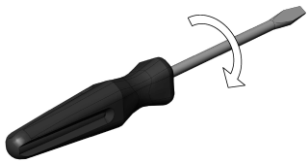

Recommended Tightening torque

0.5-0.6 Nm
4.42 - 5.30 lbf in

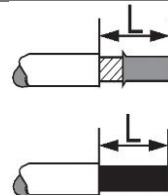

Input / output connections

Solid: 2.5 mm² / 12 AWG
Stranded: 2.5 mm² / 12 AWG
L: 6.0-7.5 mm / 0.24-0.30 in

NOTES:

- Data may change without prior notice in order to improve the product.
- Please refer to the latest version of [LDX-SC12 Datasheet](#) or [LDX-SC12 Installation Instruction](#) on our website: belfuse.com/power-solutions