

Type 0AKJ

Fast-Acting Fuse Series

0AKJ Series

RoHS Compliant

Description

Fast Acting Fuse for DC Application

Features

- Excellent DC performance
- Reliability performance design refer to ISO8820-8&GB/T31465.6
- Full compliance with EU Directive 2011/65/EU and amending directive 2015/863



Applications

EV Applications



UK CA c  CE

Physical Specifications

Materials	Body : Ceramic
	Terminals : Tin Plated Copper
Marking	On Fuse :
	"bel", "0AKJX", "Current Rating", "Interrupting Rating"
	"Voltage Rating", "Appropriate Safety Logos", "aR"
	On Label :
	"bel", "0AKJX", "Current Rating", "Voltage Rating", "Interrupting Rating", "Appropriate Safety Logos" and "  ", "  "(China RoHS compliant).

Safety Agency Approvals

Safety Agency	Safety Agency Certificate	Ampere Rating/ Voltage Rating	Ampere Range / Volt @ I.R. ability*
	E491441	150A-400A/800V DC	150A-400A/800V @ 20kA DC 150A-350A/800V @ 50kA DC 400A/750V @ 50kA DC
*I.R.= Interrupting Rating = Short Circuit Rating(Amps)			

Temperature Re-Rating Curve

Operating Temperature: -40°C to +100°C,
with proper rerating factor applied

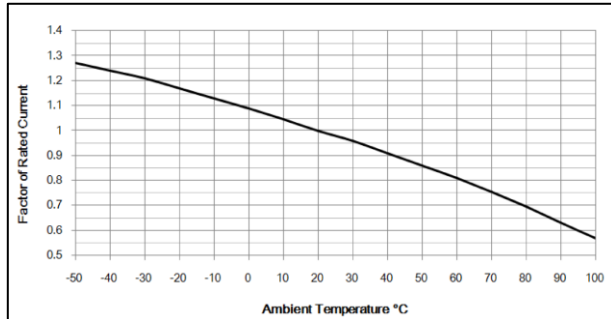

Average Time Current Curve

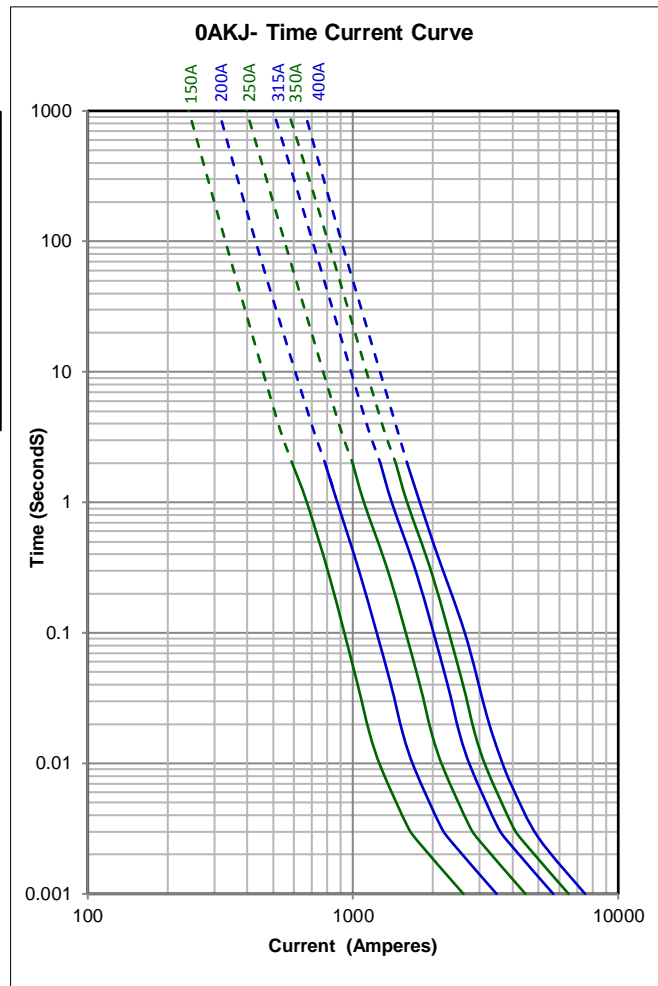

Electrical Specifications

Part Number	Ampere Rating	Voltage and Interrupting Ratings	Power loss (W)	Agency Approvals
0AKJxK150Sxx	150A	See Table of Ratings on Page 1 for Voltage and associated Interrupting Ratings	32	Y
0AKJxK200Sxx	200A		40	Y
0AKJxK250Sxx	250A		48	Y
0AKJxK315Sxx	315A		60	Y
0AKJxK350Sxx	350A		65	Y
0AKJxK400Sxx	400A		72	Y

Consult manufacturer for other ratings

*Temperature Rise: : <50K with 50% of rated current

Type 0AKJ

Fuse FGNO Explanation

0AKJ X [XXXX] -XX

0AKJB=0AKJB; [XXXX]=Ampere Rating; XX=See Ordering Information as below

Amps	Bel FGNO[XXXX]
150	K150
200	K200
250	K250
315	K315
350	K350
400	K400

Mechanical Dimensions

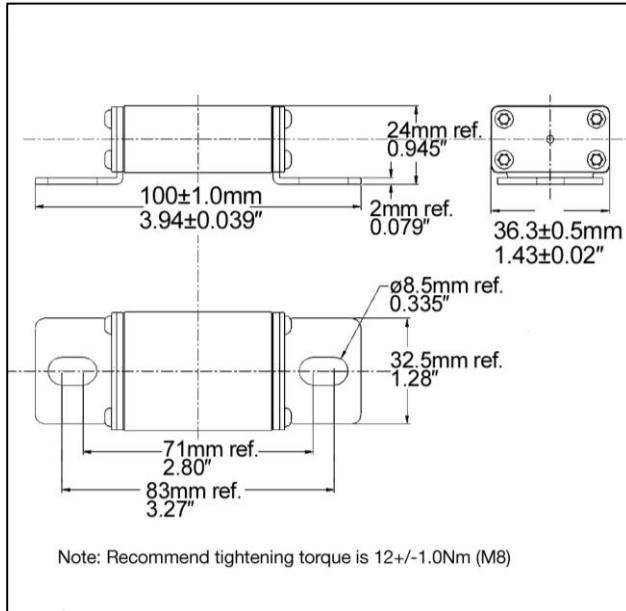

Ordering Information

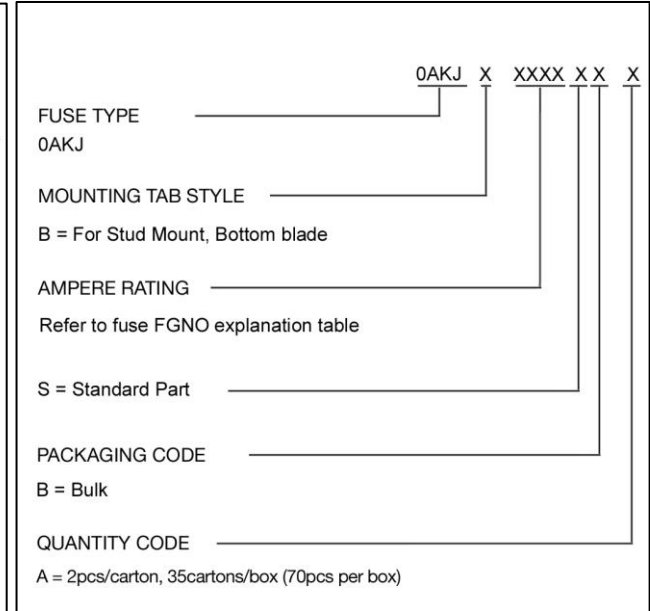

Packaging

Packaging Option	Quantity	Packaging Code
Bulk	2pcs/carton, 35cartons/box (70pcs per box)	BA